

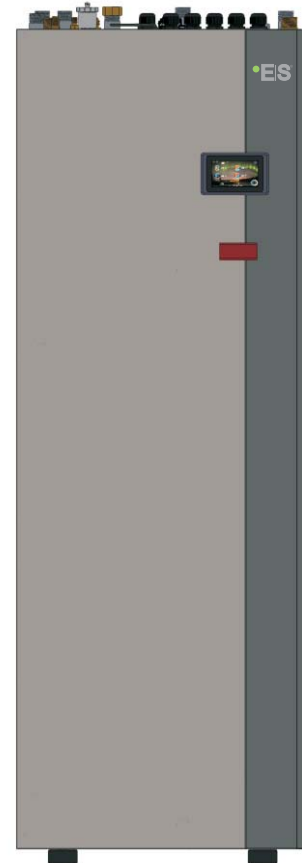

**NPT6/9/11/13-V7-S**  
**NPET6/9/11/13-V7-S**



# **DC Inverter Air to Water Heat Pump**

---

# **User's manual**

Before operating this product, please read the instructions carefully and keep this manual for future use.



# Catalogue

<b>1.Introduction</b> .....	<b>5</b>
1.1.Preliminary Information .....	5
1.2.Safety Precautions .....	6
1.3.Functioning Principles .....	8
1.4. Water pump .....	9
1.5.Product Component Diagram .....	12
1.6.Technical Specifications .....	13
<b>2.Overview of the Units</b> .....	<b>16</b>
2.1.Functional Diagrams .....	16
2.2.Outlines and Dimensions .....	19
2.3.Exploded Views .....	24
<b>3.Assembly Configurations</b> .....	<b>26</b>
Assembly Configuration Selection Flowchart .....	26
Assembly Drawings, Wiring, and Software .....	27
<b>4.Installation Walkthrough</b> .....	<b>42</b>
4.1. Sanitary Hot Water Applications .....	42
4.2.Heating and Cooling Circuits .....	43
4.3.Indoor Unit Installation .....	46
4.4.Outdoor Unit Installation .....	47
4.5.Refrigerant pipe connection .....	49
4.6.Refrigerant Pipework .....	50
4.7. Water pipe connection .....	56
4.8.Installation of the kits in the accessories .....	57
4.9. Wiring .....	59
4.10.Attention .....	70
4.11.Electric heating .....	71
4.12.Test Run .....	74
<b>5.Appendix</b> .....	<b>75</b>
A. Wiring .....	75
B. Wiring Diagrams .....	77

# Included Accessories



Below are the accessories that are included with your purchase.  
Please check to ensure that none are missing or damaged.  
If so, please contact your local distributor.

1

X1



Installation  
Manual

2

X1



User's  
Manual

3

X1



Safety  
Valve Kit

4

X1



Mixing Circuit 1  
Temperature Sensor

5

X1



Extension cable for  
Mixing Circuit 1  
Temperature Sensor

6

X1



Mixing Circuit 2  
Temperature Sensor

7

X1



Extension cable for  
Mixing Circuit 2  
Temperature Sensor

8

X1



TR-Room  
Temperature Sensor

9

X1



Extension cable for Room  
Temperature Sensor

10

X1



Communication  
Cable between  
Indoor and  
Outdoor Unit

# 1. Introduction

---

## 1.1 Preliminary Information

---

Thank you for your purchase of our quality heat pump.

This manual is intended to provide detailed instructions for the successful installation of your newly purchased heat pump product. Please ensure that this manual, along with the User's and Service manuals, are kept in an easy-to-access location for your reference later on.

### DISCLAIMER

Proper adherence to the directions provided herein is vital for both the smooth operation of this system, as well as for your safety and the safety of those around you. ES Heat Pumps AB. is not responsible or liable for any losses incurred due to misuse or mishandling of this product, which includes, but is not limited to:

- Purchasing, installing, and/or operating this product with the intention of using it outside of its established, technical purpose.
- Carrying out improper work upon the unit, or any of its components, that has not been given explicit, prior consent in the form of writing.
- Installation attempts of this system by anyone other than a properly trained and licensed professional.
- Negligence of properly-worn personal protection (safety glasses, gloves, etc.) while performing installation, maintenance, or servicing of this product.
- The operation of this system during ambient temperatures which are below or beyond the temperature range intended (-25°C to 45°C)

### SAFETY

If unsure of what installation procedures to use, please contact your local distributor for information and/or advisement. Any accessories used with this product must be official only. Any electrical work must be carried out by certified electricians only. The manufacturer is not responsible for any alterations or modifications that are made without explicit, written approval. The design of this unit complies and conforms to all necessary and relevant safety regulations, and is otherwise safe to operate for its intended use.

Please pay attention to the following pages, which detail important precautions that should be closely followed, to ensure safe installation and operation .

# 1. Introduction

## 1.2. Safety Precautions

To ensure both your personal safety, as well as the safety of the product, note the symbols below and be sure to understand their correlation to each of the precautions depicted.





Warning





Caution

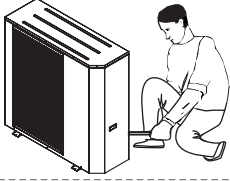



Prohibition

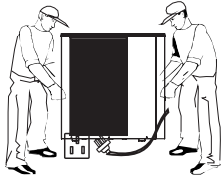

The installation, dismantlement and maintenance of the unit must be performed by qualified personnel. It is forbidden to do any changes to the structure of the unit. Otherwise injury of person or unit damage might happen.



To avoid electrical shock, make sure to disconnect the power supply 1 minute or more before servicing the electrical parts. Even after 1 minute, always measure the voltage at the terminals of main circuit capacitors or electrical parts and, before touching, make sure that those voltages are lower than the safety voltage.

Be sure to read this manual before use.

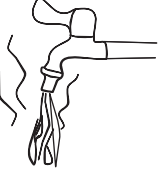

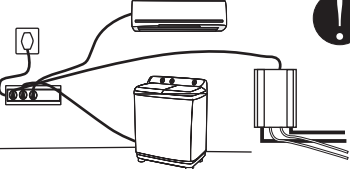

For sanitary hot water, please always add a mixture valve before water tap and set it to proper temperature.



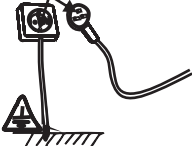

Use a dedicated socket for this unit, otherwise malfunction may occur.



Ground wire



The power supply to the unit must be grounded.

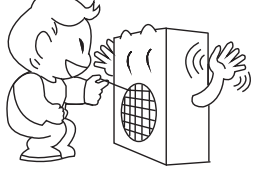

This appliance can be used by children aged from 8 years and above and persons with reduced physical, sensory or mental capabilities or lack of experience and knowledge if they have been given supervision or instruction concerning use of the appliance in a safe way and understand the hazards involved. Children shall not play with the appliance. Cleaning and user maintenance shall not be made by children without supervision.

Do not touch the air outlet grill when fan motor is running.





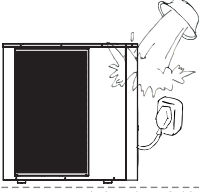

Do not touch the power plug with wet hands. Never pull out the plug by pulling the power cable.

Water or any kind of liquid is strictly forbidden to be poured into the product, or may cause electric creepage or breakdown of the product.

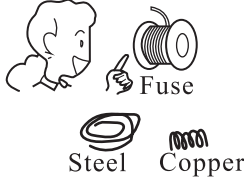
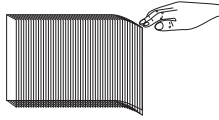
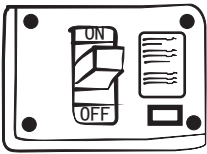
# 1. Introduction

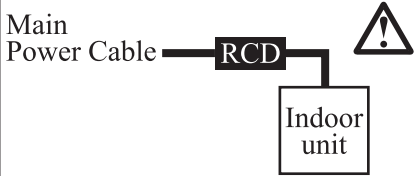
## 1.2. Safety Precautions

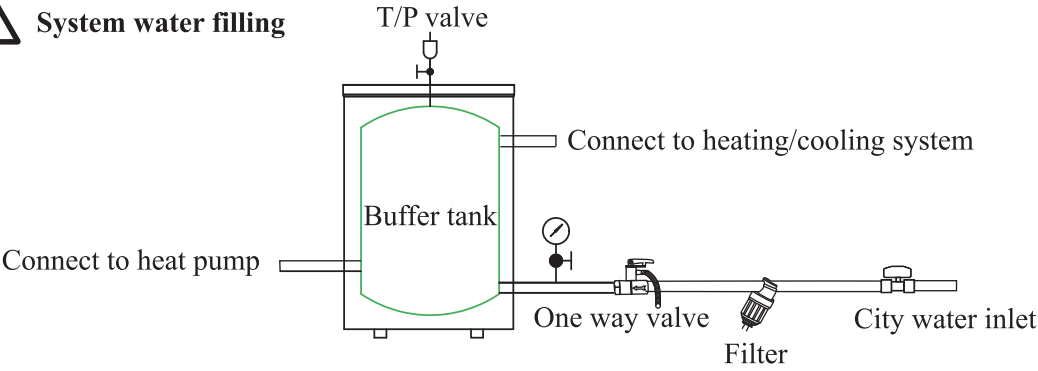
 <p>When the power cord gets loose or damaged, always get a qualified person to fix it.</p>	 <p>Please select the correct fuse or breaker as per recommended. Steel wire or copper wire cannot be taken as substitute for fuse or breaker. Otherwise, damages maybe caused.</p>	 <p>Be aware fingers might be hurt by the fin of the coil.</p>
 <p>It is mandatory to use a suitable circuit breaker for the heat pump and make sure the power supply to the unit corresponds to the specifications. Otherwise the unit might be damaged.</p>	 <p>Disposal of Scrap Batteries (if there is). Please discard the batteries as sorted municipal waste at the accessible collection point.</p>	 <p>Installation of a residual current device (RCD) having a rated residual operating current not exceeding 30 mA is advisable.</p>
<p> <b>System water filling</b></p> 		
<p>1. It's suggested to use pure water for filling the system.          2. If use city water for filling, please soften the water and add a filter.          Note: After filling, the system of water system should be 0.15~0.6MPa.</p>		
<p> </p> <p>This marking indicates that this product should not be disposed with other household wastes throughout the EU. To prevent possible harm to the environment or human health from uncontrolled waste disposal, recycle it responsibly to promote the sustainable reuse of material resources. To return your used device, please use the return and collection systems or contact the retailer where the product was purchased. They can take this product for environmental safe recycling.</p>		

# 1. Introduction

## 1.3. Functioning Principles

NPT6/9/11/13-V7-S

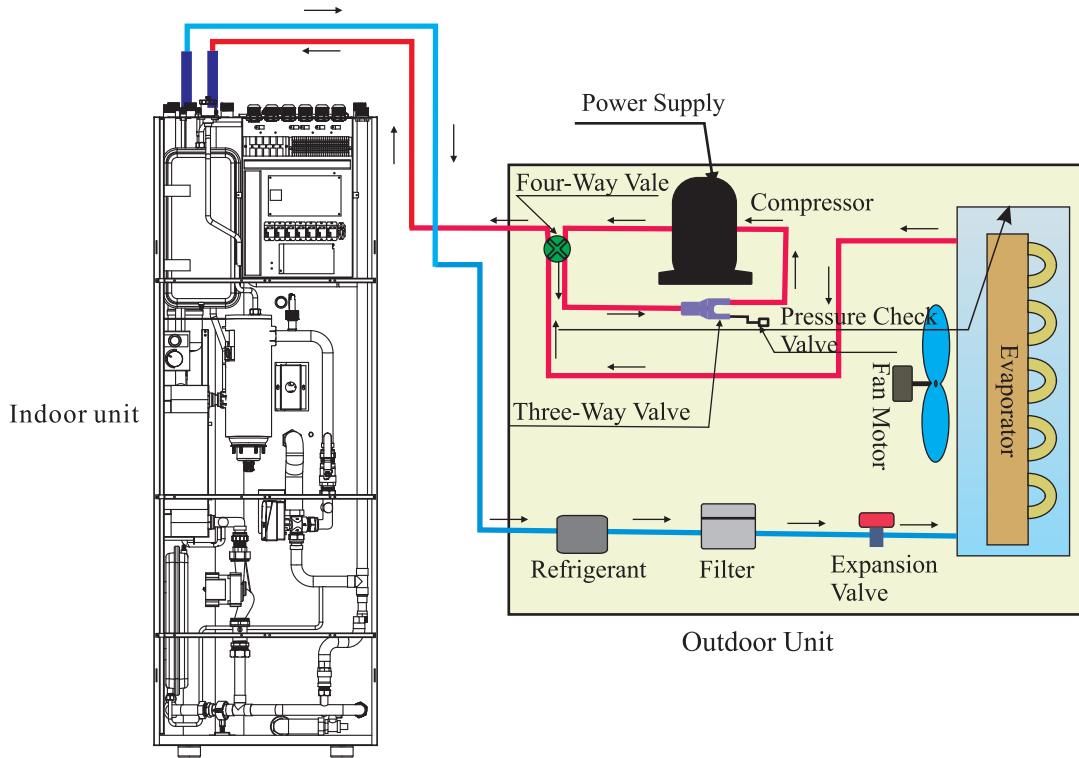



# 1. Introduction

## 1.4. Water Pump

### Setting the pump speed

The pump speed can be selected on the pump. The default setting is highest speed. If the water flow in the system is too high (e.g. noise of running water in the installation) the speed can be lowered.

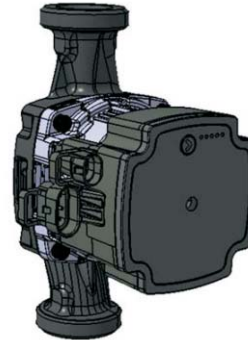
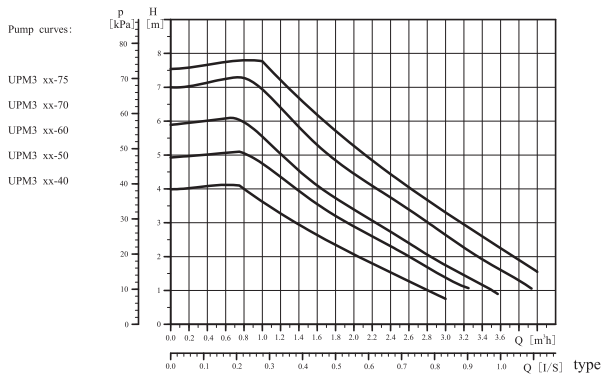

### User interface

The user interface is designed with a single push button, one red/green LED and four yellow LEDs.

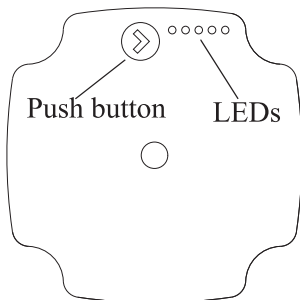

User interface with one push button and five LEDs

The user interface shows:

- performance view (during operation)
  - operation status
  - alarm status
- settings view (after pressing the button).

During operation, the display shows the performance view. If you press the button, the user interface switches the view or runs in the setting selection mode.

The user interface shows:

- performance view (during operation)
  - operation status
  - alarm status
- settings view (after pressing the button).

During operation, the display shows the performance view. If you press the button, the user interface switches the view or runs in the setting selection mode.

### Performance view

The performance view shows either the operation status or the alarm status.

### Operation area

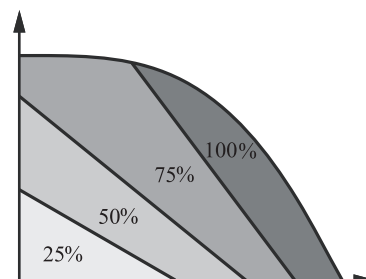

Fig. 1 Operation area according to performance load

# 1. Introduction

## 1.4. Water Pump

### Operation status

When the circulator is running, LED 1 is green. The four yellow LEDs indicate the current power consumption (P1) as shown in the table below. See fig. 1. When the operation mode is active, all active LEDs are constantly on in order to differentiate this mode from the select setting mode. If the circulator is stopped by an external signal, LED 1 flashes green.

Display	Indication	Performance in % of P1 MAX
One green LED (flashing)	Standby (only externally controlled)	0
One green LED + one yellow LED	Low performance	0-25
One green LED + two yellow LED	Medium low performance	25-50
One green LED + three yellow LED	Medium high performance	50-75
One green LED + four yellow LED	High performance	75-100

### Navigation

#### Key lock function

The purpose of the key lock function is to avoid accidental change of settings and misuse.

When the key lock function is enabled, all long key presses will be ignored. This prevents the user from entering the "select setting mode" area and allows the user to see the "show setting mode" area.

If you press the key lock for more than 10 seconds, you can toggle between enabling/disabling the key lock function. When doing so, all LEDs, except for the red LED, will flash for a second indicating that lock is toggled.



### Alarm status

If the circulator has detected one or more alarms, the bi-colored LED 1 switches from green to red. When an alarm is active, the LEDs indicate the alarm type as defined in the table below. If multiple alarms are active at the same time, the LEDs only show the error with the highest priority. The priority is defined by the sequence of the table.

When there is no active alarm anymore, the user interface switches back to operation mode.

Display	Indication	Pump operation	Counter action
One red LED + one yellow LED (LED 5)	Rotor is blocked.	Trying to start again every 1.33 seconds.	Wait or block the shaft.
One red LED + one yellow LED (LED 4)	Supply voltage too low.	Only warning, pump runs.	Control the supply voltage.
One red LED + one yellow LED (LED 3)	Electrical error.	Pump is stopped because of low supply voltage or serious failure.	Control the supply voltage / Exchange the pump.

### User interface control modes for UPM3 HYBRID variants

You can manage all UPM3 HYBRID variants with a single push button and a LED interface.

You can select the following operation modes with the push button.

The user interface shows the flashing LEDs in the combination which is described in the tables below.

#### UPM3 FLEX AS

This circulator is for either external PWM profile A signal control or speed selection.

You can define the maximum curve of the pump operation range. With PWM signal, the circulator runs at the corresponding speed. Without PWM signal, the circulator runs at maximum speed.

#### PWM profile A (heating)

UPM3 xx-70 [m]	LED1 red	LED2 yellow	LED3 yellow	LED4 yellow	LED5 yellow
4	•	•			
5	•	•		•	
6	•	•		•	•
7*	•	•			•

\* The circulator is factory-set to start in this control mode.

# 1. Introduction

---

## 1.4. Water Pump

---

### Factory presetting

The circulator starts at the factory preset.

- For standard UPM3 HYBRID, UPM3 AUTO, UPM3

AUTO L this is proportional pressure, curve 3

- For UPM3 FLEX AC and UPM3 FLEX AS this is PWM profile A, curve 4.

In the "select setting" mode the circulator starts at this control mode. The preset mode is marked with this symbol \* in the tables below.

### Setting selection

You can choose between the performance view and settings view.

If you press the button for 2 to 10 seconds, the user interface switches to "setting selection" if the user interface is unlocked. You can change the settings as they appear. The settings appear in a particular order in a closed loop. When you release the button, the user interface switches back to the performance view and the last setting is stored.

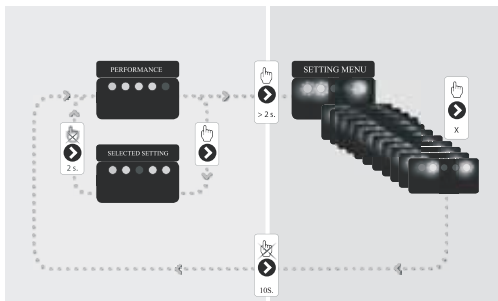

Setting selection

# 1. Introduction

## 1.5. Product Components Diagram

Below is a general system application of the heat pump. Any specific configurations should be a variation of this “master” system drawing. All suggested assembly variations are given in Chapter 3.

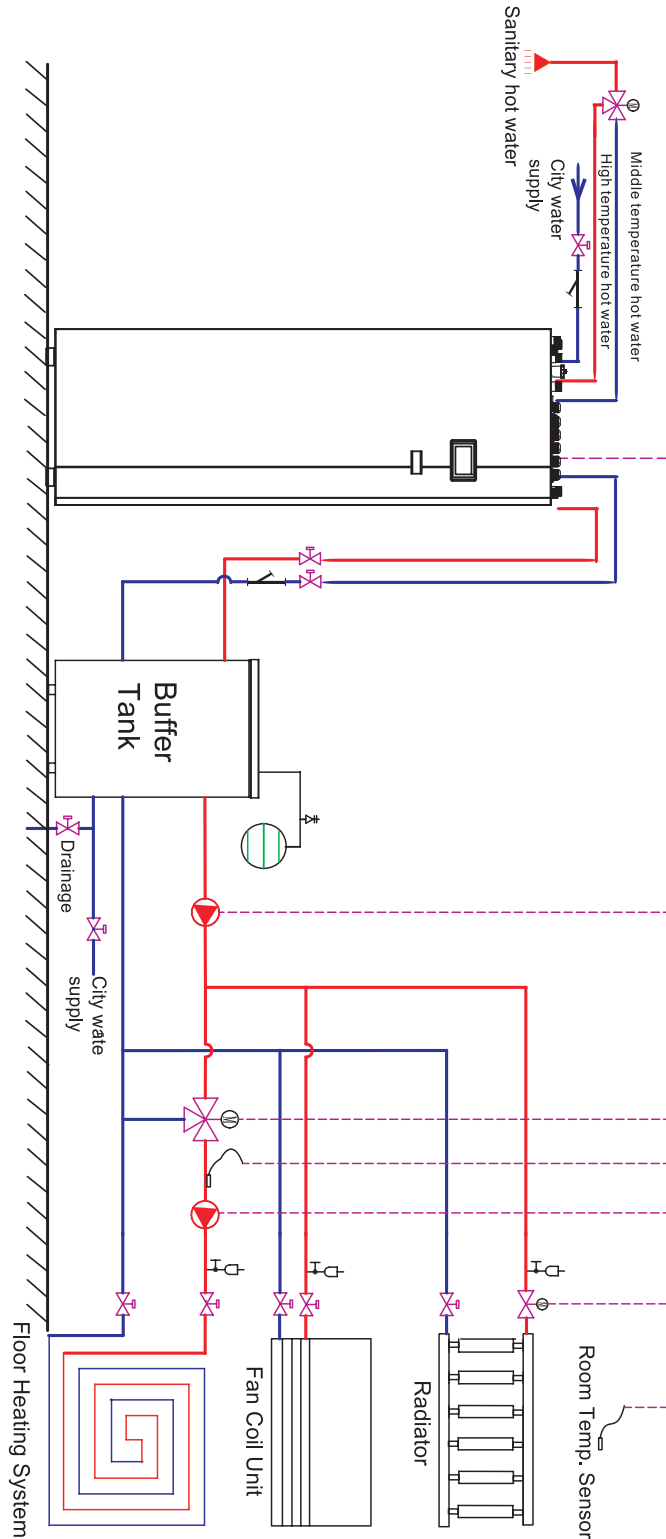

Name	Symbol	Name	Symbol
Temp. Sensor		Water pump	
Safety valve Kit		Mixing valve	
Ball valve		Motorized valve	
Water filter		Expansion tank	
Air purging valve			

Note: Dotted lines mean “able to be controlled by the Heat Pump”.

# 1. Introduction

## 1.6. Technical Specifications

MODEL		NPT6-V7-S	NPET6-V7-	NPT9/11-V7-S	
ES code	Indoor	120271	120272	120275	120275
ES code	Outdoor	120273	120273	120277	120278
ErP Energy efficiency class		A+++	A+++	A++	
SCOP 35°C (floor heating) EN 14825	W/W	4.47	4.47	3.99	3.92
Pdesign for SCOP EN 14825	kW	5.26	5.26	6.4	8.26
<b>Heating mode(A7/W35)*</b>					
Heating capacity*	kW	2.19-6.21	2.19-6.21	4.33-10.10	4.67-11.5
COP - Coefficient of Performance*	W/W	4.05-5.87	4.05-5.87	4.02-4.65	3.83-5.05
Rated input power*	kW	0.54-1.53	0.54-1.53	0.975-2.15	0.92-3.03
<b>Heating mode(A7/W45)</b>					
Heating capacity	kW	2.05-5.80	2.05-5.80	4.19-9.53	4.14-10.7
COP - Coefficient of Performance	W/W	3.22-4.12	3.22-4.12	3.12-3.55	2.95-3.56
Rated input power	kW	0.64-1.81	0.64-1.81	1.23-2.99	1.22-3.62
Max. temperature of heating water	°C	55	55	55	
Operating range heating	°C	-25 to +45	-25 to +45	-25 to +45	
<b>Cooling mode (A35/W7)**</b>					
Cooling capacity**	kW	2.52-4.32	2.52-4.32		
Rated input power**	kW	-1.59-4.5	-1.59-4.5	2.34-5.05	2.17-6.74
EER - Energy Efficiency Ratio	W/W	0.61-1.74	0.61-1.74	1.08-3.20	0.92-3.13
Min. temperature of cooling water	°C	7	7	7	
Operating range cooling	°C	0 to +65	0 to +65	0 to +65	
<b>Power supply - specifications</b>					
Voltage	V/Hz/Ph	400V/3PH/50Hz 230V/3PH/50Hz	400V/3PH/50Hz 230V/3PH/50Hz	400V/3PH/50Hz 230V/3PH/50Hz	
Fuse for heat pump alone (with 230V/1PH/50Hz connection)	A/type	10A/C (230V)	10A/C (230V)	16A/C (230V)	
Fuse for heat pump + electric back up	A/type	16A/C (400V) 25A/C (230V)	16A/C (400V) 25A/C (230V)	16A/C (400V) 25A/C (230V)	
Electrical flow heater	kW/ph	6(9)kW 2x3kW+(3kW)	6(9)kW 2x3kW+(3kW)	6(9)kW 2x3kW+(3kW)	
DHW tank electrical heater (HWTBH)	kW/ph	0.5kW/(1ph / 1 stage)	1.5kW/(1ph / 1 stage)	0.5kW/(1ph / 1 stage)	
<b>Refrigerant specification</b>					
Type of refrigerant	/	R410A	R410A	R410A	
Refrigerant - mass	kg	1.3	1.3	2.5	2.55
GWP (global warming potential)	GWP	2088	2088	2088	
Quantity of hydrofluorocarbons in tonnes of Co <sub>2</sub> equivalent	t CO <sub>2</sub> Equiv.	2.714	2.714	5.220	5.324
Max pressure high side	kPa	42,000	42,000	42,000	
Type of compressor	/	DC inverter (twin rotary)	DC inverter (twin rotary)	DC inverter (twin rotary)	
Hermetically sealed equipment (indoor/outdoor unit)		Yes	Yes	Yes	
Type to connection between outdoor-indoor unit	Refrigerant / Water	Refrigerant connection	Refrigerant connection	Refrigerant connection	
Dimensions of refrigerant pipes connectors	Liquid - Gas	1/4"-1/2"	1/4"-1/2"	3/8"-1/2"	
Factory pre-load for pipe distance	m	5	5	5	
Max. Refrigerant pipe distance	m	15	15	20	
Refrigerant charge for each additional meter	g/m	40	40	40	
<b>Height difference between outdoor and indoor unit</b>					
***Outdoor unit is above Indoor unit	m	7	7	7	
***Outdoor unit is below Indoor unit	m	5	5	5	
<b>Fan</b>					
Fan type	/	1x Axial	1x Axial	1x Axial	
Air flow	m <sup>3</sup> /h	2700	2700	3000	3100
Rated power	W	60	60	60	
..ESP" - External Static Pressure of the Fan (data per piece)	Pa	45	45	45	
<b>Water side heat exchanger</b>					
Type	/	SWEP	SWEP	SWEP	
Pressure drop	kPa	30	30	40	
Dimensions of water piping connection	Inch	G1"	G1"	G1"	
<b>DHW Tank</b>					
Water volume - bruto	l	250	250	250	
Water volume - neto	l	250	230	250	
DHW Heat Exchanger Surface/ length	m <sup>2</sup> /l	/	2.7	/	
Expansion vessel heating water	l	6+5	NA	6+5	
<b>Allowable flow - secondary (water) side</b>					
Min. water flow	l/s / m <sup>3</sup> /h	0.91 l/s or 0.68 m <sup>3</sup> /h	0.91 l/s or 0.68 m <sup>3</sup> /h	0.23 l/s or 0.86 m <sup>3</sup> /h	0.31 l/s or 1.11 m <sup>3</sup> /h
Nominal water flow	m <sup>3</sup> /h	1.04	1.04	1.44	
Max. water flow	m <sup>3</sup> /h	1.18	1.18	2.16	
Circulation water pump - A energy class	Type	UPM3K FLEX AS 25-75 180 AZA	UPM3K FLEX AS 25-75 180 AZA	UPM3K FLEX AS 25-75 180 AZA	
<b>Sound power level according to En12102</b>					
Sound power level L <sub>WA</sub> - Indoor unit	dB(A)	47.2	47.2	43	45
Sound power level L <sub>WA</sub> - Outdoor unit	dB(A)	57.3	57.3	58	58
<b>Sound pressure level on distance:</b>					
Indoor unit -1m	dB(A)	42.2	42.2	32	37
Outdoor unit -1m	dB(A)	49.3	49.3	49.9	49.9
Outdoor unit -2 m	dB(A)	43.3	43.3	43.9	43.9
Outdoor unit -4 m	dB(A)	37.3	37.3	37.8	37.8
Outdoor unit -5 m	dB(A)	35.4	35.4	35.9	35.9
Outdoor unit -8 m	dB(A)	31.3	31.3	31.8	31.8
Outdoor unit -10 m	dB(A)	29.4	29.4	29.9	29.9
Outdoor unit -15 m	dB(A)	25.8	25.8	26.3	26.3
<b>Net dimensions</b>					
Indoor unit (WxHxD)	mm	600x1780x680	600x1860x730	600x1780x680	
Outdoor unit (WxHxD)	mm	920x353x730	920x353x730	947x355x755	1056x414x765
<b>Packing dimensions</b>					
Indoor unit (WxHxD)	mm	650x1960x750	650x2000x790	650x1960x750	
Outdoor unit (WxHxD)	mm	1010x440x880	1010x440x880	1010x440x810	1140x490x810
<b>Net weight</b>					
Indoor unit	kg	125	186	130	
Outdoor unit	kg	52.6	52.6	67.5	70
<b>Packing weight</b>					
Indoor unit	kg	133	201	144	
Outdoor unit	kg	63	63	77.5	80

# 1. Introduction

## 1.6. Technical Specifications

MODEL		NPET9/11-V7-S		NPT13-V7-S	NPET13-V7-S
ES code	Indoor	120276	120276	120280	120281
ES code	Outdoor	120277	120278	120282	120282
ErP Energy efficiency class		A++		A++	A++
SCOP 35°C (floor heating) EN 14825	W/W	3.99	3.92	4.08	4.08
Pdesign for SCOP EN 14825	kW	6.4	8.26	7.46	7.46
<b>Heating mode(A7/W35)*</b>					
Heating capacity*	kW	4.33-10.10	4.67-11.5	4.2-12.6	4.2-12.6
COP - Coefficient of Performance*	W/W	4.02-4.65	3.83-5.05	3.89-4.77	3.89-4.77
Rated input power*	kW	0.975-2.15	0.92-3.03	0.926-3.07	0.926-3.07
<b>Heating mode(A7/W45)</b>					
Heating capacity	kW	4.19-9.53	4.14-10.7	3.76-11.5	3.76-11.5
COP - Coefficient of Performance	W/W	3.12-3.55	2.95-3.56	2.95-3.28	2.95-3.28
Rated input power	kW	1.23-2.99	1.22-3.62	1.27-3.72	1.27-3.72
Max. temperature of heating water	°C	55		55	55
Operating range heating	°C	-25 to +45		-25 to +45	-25 to +45
<b>Cooling mode (A35/W7)**</b>					
Cooling capacity**	kW	2.34-5.05	2.17-6.74	2.34-7.91	2.34-7.91
Rated input power**	kW	1.08-3.20	0.92-3.13	1.0-3.01	1.0-3.01
EER - Energy Efficiency Ratio	W/W	1.58-2.40	2.15-3.0	2.33-3.12	2.33-3.12
Min. temperature of cooling water	°C	7		7	7
Operating range cooling	°C	0 to +65		0 to +65	0 to +65
<b>Power supply - specifications</b>					
Voltage	V/Hz/Ph	400V/3PH/50Hz 230V/3PH/50Hz		400V/3PH/50Hz 230V/3PH/50Hz	400V/3PH/50Hz 230V/3PH/50Hz
Fuse for heat pump alone (with 230V/1PH/50Hz connection)	A/type	16A/C (230V)		16A/C (230V)	16A/C (230V)
Fuse for heat pump + electric back up	A/type	16A/C (400V) 25A/C (230V)		16A/C (400V) 25A/C (230V)	16A/C (400V) 25A/C (230V)
Electrical flow heater	kW/ph	6(9)kW 2x3kW+(3kW)		6(9)kW 2x3kW+(3kW)	6(9)kW 2x3kW+(3kW)
DHW tank electrical heater (HWTBH)	kW/ph	1.5kW/(1ph / 1 stage)		0.5kW/(1ph / 1 stage)	1.5kW/(1ph / 1 stage)
<b>Refrigerant specification</b>					
Type of refrigerant	/	R410A		R410A	R410A
Refrigerant - mass	kg	2.5	2.55	3	3
GWP (global warming potential)	GWP	2088		2088	2088
Quantity of hydrofluorocarbons in tonnes of Co. equivalent	t CO <sub>2</sub> Equiv.	5.220	5.324	6.264	6.264
Max pressure high side	kPa	42.000		42.000	42.000
Type of compressor	/	DC inverter (twin rotary)		DC inverter (twin rotary)	DC inverter (twin rotary)
Hermetically sealed equipment (indoor/outdoor unit)	/	Yes		Yes	Yes
Type fo connection between outdoor-indoor unit		Refrigerant connection		Refrigerant connection	Refrigerant connection
Dimensions of refrigerant pipes connectors	Liquid - Gas	3/8"-1/2"		3/8"-5/8"	3/8"-5/8"
Factory pre-load for pipe distance	m	5		12	12
Max. Refrigerant pipe distance	m	20		20	20
Refrigerant charge for each additional meter	g/m	40		40	40
<b>Height difference between outdoor and indoor unit</b>					
***Outdoor unit is above Indoor unit	m	7		7	7
***Outdoor unit is below Indoor unit	m	5		5	5
<b>Fan</b>					
Fan type	/	1x Axial		2x Axial	2x Axial
Air flow	m <sup>3</sup> /h	3000		4200	4200
Rated power	W	60		2x60	2x60
„ESP“ – External Static Pressure of the Fan (data per piece)	Pa	45		50	50
<b>Water side heat exchanger</b>					
Type	/	GEA		SWEP	SWEP
Pressure drop	kPa	40		40	40
Dimensions of water piping connection	Inch	G1"		G1"	G1"
<b>DHW Tank</b>					
Water volume - bruto	l	250		250	250
Water volume - neto	l	230		250	230
DHW Heat Exchanger Surface/ lenght	m <sup>2</sup> /l	2.7		/	2.7
Expansion vessel heating water	l	NA		6+5	NA
<b>Allowable flow - secondary (water) side</b>					
Min. water flow	l/s / m <sup>3</sup> /h	0.23 l/s or 0.86 m <sup>3</sup> /h	0.31 l/s or 1.11 m <sup>3</sup> /h	0.37 l/s or 1.32 m <sup>3</sup> /h	0.37 l/s or 1.32 m <sup>3</sup> /h
Nominal water flow	m <sup>3</sup> /h	1.44		2.2	2.2
Max. water flow	m <sup>3</sup> /h	2.16		2.63	2.63
Circulation water pump - A energy class	Type	UPM3K FLEX AS 25-75 180 AZA		UPM3K FLEX AS 25-75 180 AZA	UPM3K FLEX AS 25-75 180 AZA
<b>Sound power level according to En12102</b>					
Sound power level L <sub>WA</sub> - Indoor unit	dB(A)	43	45	46	46
Sound power level L <sub>WA</sub> - Outdoor unit	dB(A)	58	58	59	59
<b>Sound pressure level on distance:</b>					
Indoor unit -1m	dB(A)	32	37	38	38
Outdoor unit -1m	dB(A)	49.9	49.9	51	51
Outdoor unit -2 m	dB(A)	43.9	43.9	45	45
Outdoor unit -4 m	dB(A)	37.8	37.8	39	39
Outdoor unit -5 m	dB(A)	35.9	35.9	37.1	37.1
Outdoor unit -8 m	dB(A)	31.8	31.8	33	33
Outdoor unit -10 m	dB(A)	29.9	29.9	31.1	31.1
Outdoor unit -15 m	dB(A)	26.3	26.3	27.5	27.5
<b>Net dimensions</b>					
Indoor unit (WxHxD)	mm	600x1860x730		600x1780x680	600x1860x730
Outdoor unit (WxHxD)	mm	947x355x755	1056x414x765	1154x460x1195	1154x460x1195
<b>Packing dimensions</b>					
Indoor unit (WxHxD)	mm	650x2000x790		650x1960x750	650x2000x790
Outdoor unit (WxHxD)	mm	1010x440x810	1140x490x810	1260x490x1355	1260x490x1355
<b>Net weight</b>					
Indoor unit	kg	190		125	190
Outdoor unit	kg	67.5	70	118	118
<b>Packing weight</b>					
Indoor unit	kg	205		144	205
Outdoor unit	kg	77.5	80	128	128

# 1. Introduction

---

## 1.6. Technical Specifications

---

(\*) Measured according to standard EN 14511. Heating condition: water inlet/outlet temperature 30°C/35°C. ambient temperature DB/WB7°C/6°C.

(\*\*) Measured according to standard EN 14511. Cooling condition: water inlet/outlet temperature 12°C/7°C and ambient temperature 35°C.

## 2. Overview of the Units

### 2.1. Functional Diagrams

#### 【 Indoor unit 】

NPT6/9/11/13-V7-S

Outside

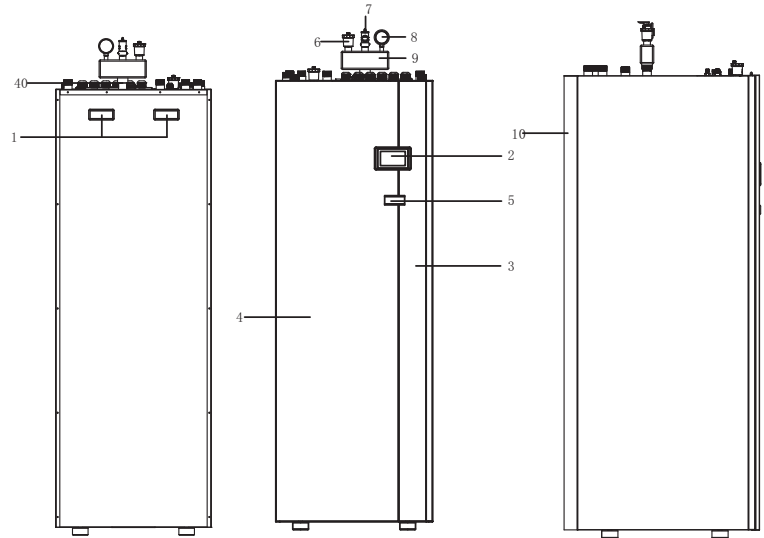

Top

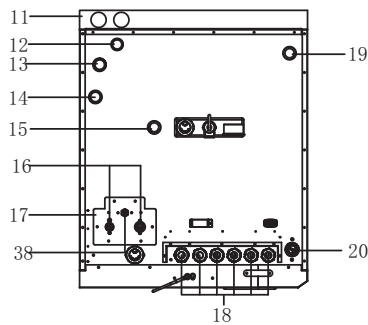

Inside

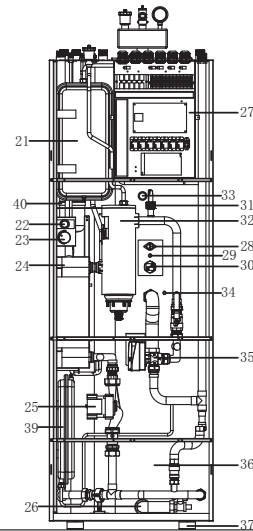

NO.	Name
1	Handle
2	Touch screen operation panel
3	Decorative panel
4	Front panel
5	Digital thermostat
6	Automatic air purging valve
7	T/P valve
8	Water pressure gauge
9	Four-way safety valve kit
10	L type decorative panel in back side 1
11	L type decorative panel in back side 2
12	Middle temperature hot water outlet(G1"male)
13	Filling water to coil(G1"male)
14	Filling water to water tank(G3/4"male)
15	High temperature hot water outlet(G1"male)
16	6kW Refrigerant connector(1/4"~1/2") 9/11kW Refrigerant connector(3/8"~1/2") 13kW Refrigerant connector(3/8"~5/8")
17	Fixing plate for refrigerant connector
18	Cable gland
19	Water from heating/cooling system(G1"male)
20	Water to heating/cooling system(G1"male)

NO.	Name
21	Water expansion tank
22	Emergency Switch for 9KW electric heater
23	Thermostat knob
24	Plate heat exchanger
25	Water pump
26	Drainage
27	Electric box
28	Overheating protector for 500W electric heater
29	Temperature sensor for 500W electric heater
30	500W electric heater 230V/50Hz/1Ph
31	Water flow switch
32	9KW electric heater 400V/50Hz/1Ph
33	Anode Rod
34	Temperature sensor for hot water mode
35	Motorized three-way valve
36	Water tank
37	Rubber absorber feet
38	Service valve
39	5L Expansion Tank
40	1.5L refrigerant expansion tank (6/9/11kW)



## 2. Overview of the Units

### 2.1. Functional Diagrams

#### 【 Indoor unit 】

NPT6/9/11/13-V7-S

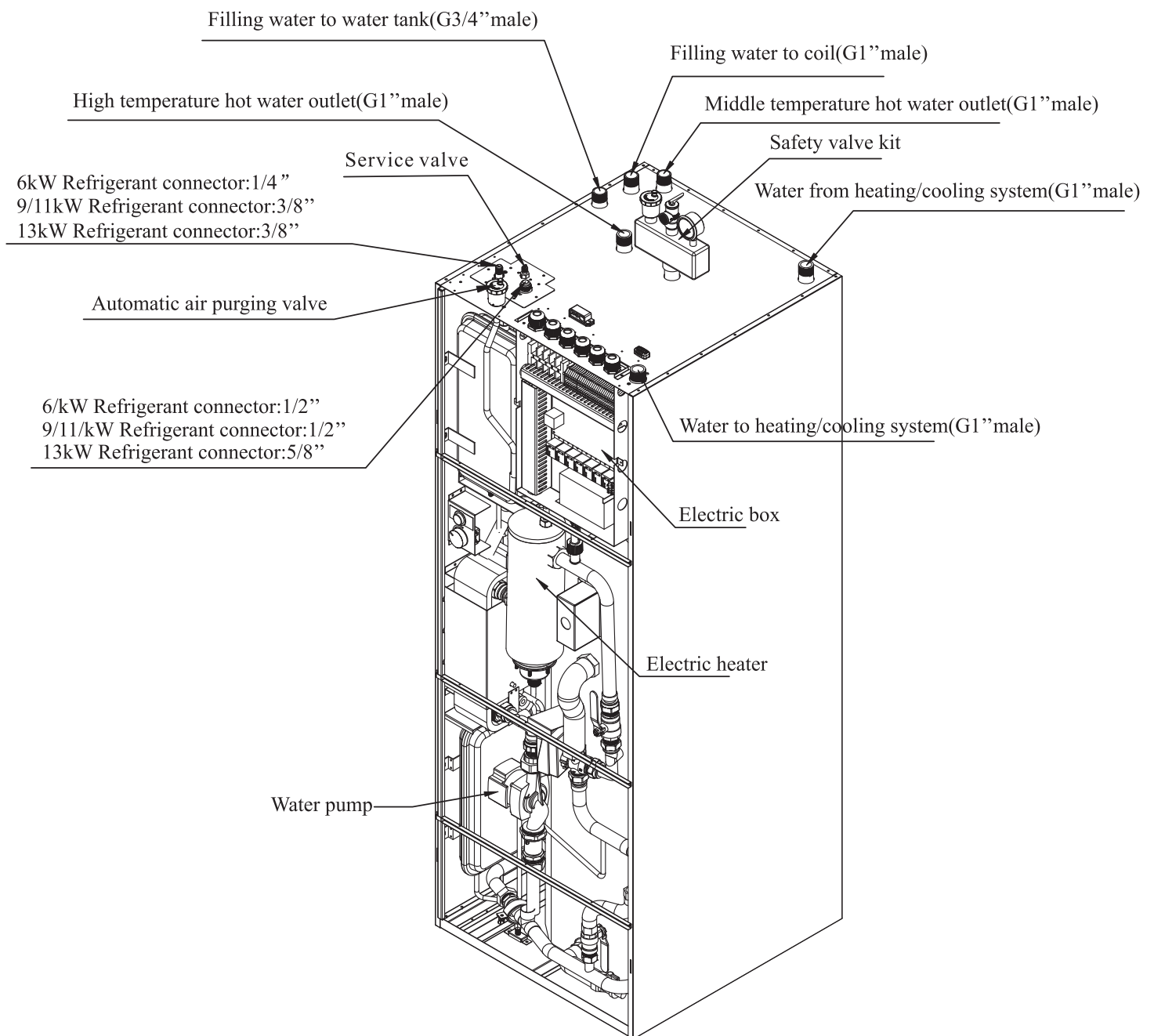

## 2. Overview of the Units

### 2.1. Functional Diagrams

#### 【 Indoor unit 】

NPET6/9/11/13-V7-S

Nordic Plus Enamelled Tank 6kW All-in-One

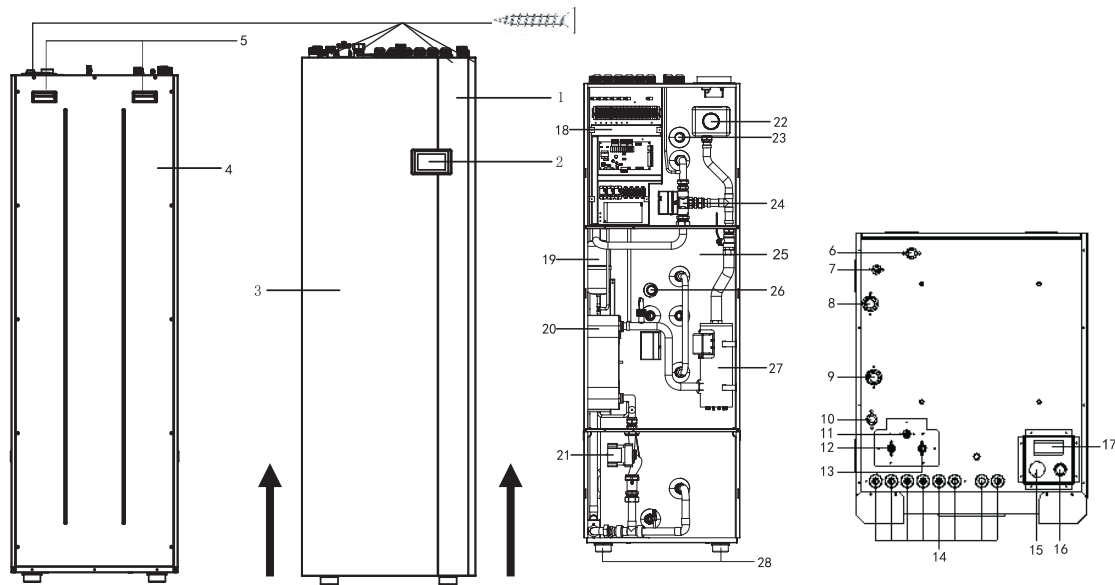

NO.	Name
1	Decorative panel
2	Touchscreen Controller Panel
3	Front Panel
4	Side Panel
5	Handle
6	DHW Cold water 3/4"
7	DHW Circulation 1/2"
8	Heating/Cooling Return 1"
9	Heating/Cooling Output 1"
10	DHW Hot water 3/4"
11	Pin Valve
12	Refrigerant Connector
13	Refrigerant Connector 1/2"
14	Cable Gland

NO.	Name
15	Mechanical Thermostat
16	Emergency switch
17	Digital thermostat
18	Electric box
19	1.5L Refrigerant tank
20	Plate heat exchanger
21	Circulation Pump
22	Safety Valve Kit
23	Magnesium Anode-1
24	Motorized 3-way valve
25	250L Enamelled tank
26	Magnesium Anode-2
27	Electric heater
28	Rubber damping

## 2. Overview of the Units

### 2.2.Outlines and Dimensions

#### 【 Indoor unit 】

NPT6/9/11/13-V7-S

Unit:mm

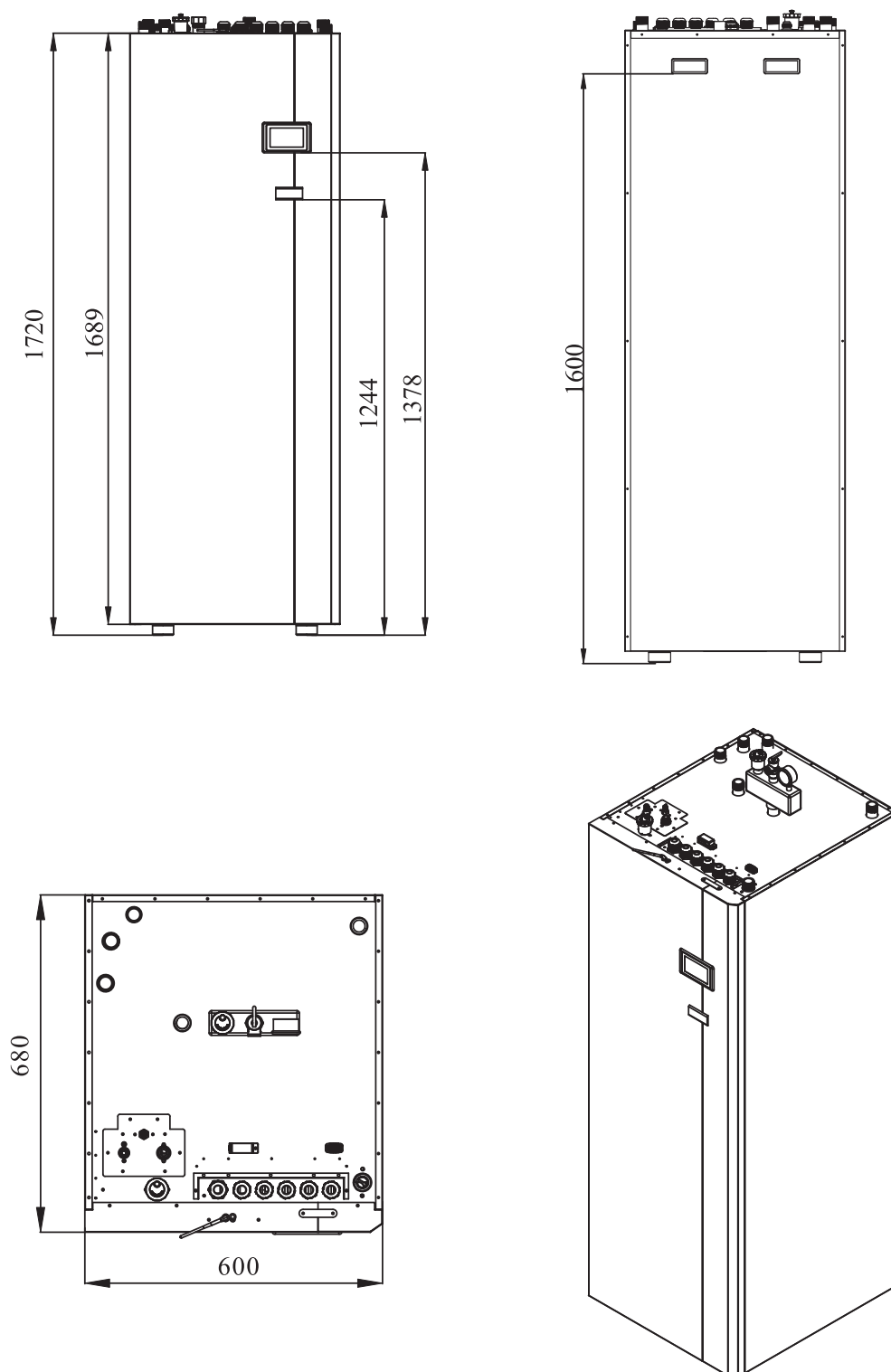

## 2. Overview of the Units

### 2.2.Outlines and Dimensions

#### 【 Indoor unit 】

NPET6/9/11/13-V7-S

Unit:mm

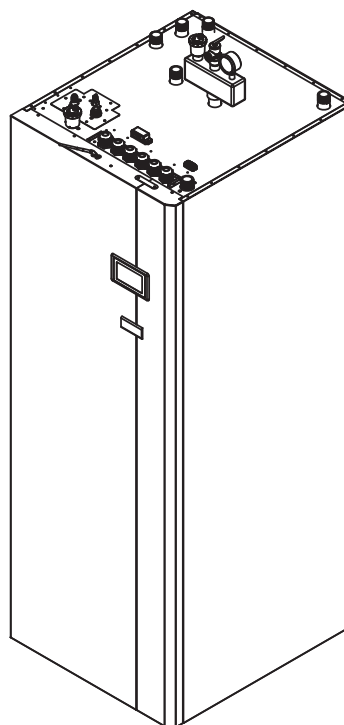
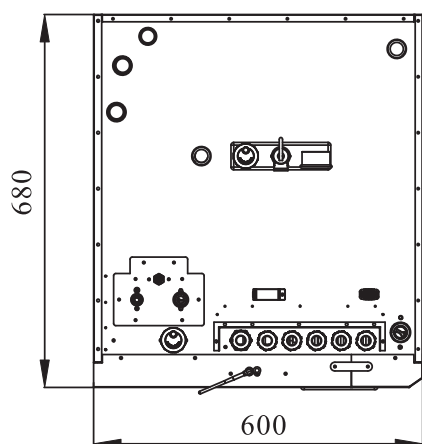
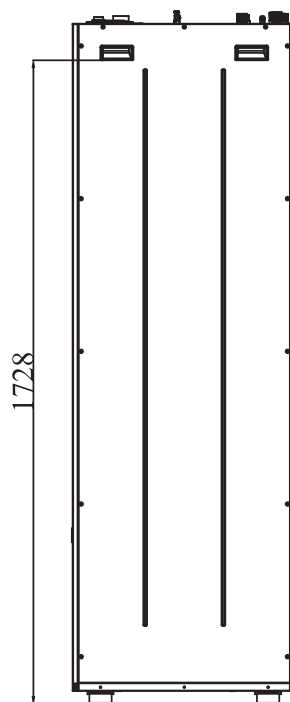
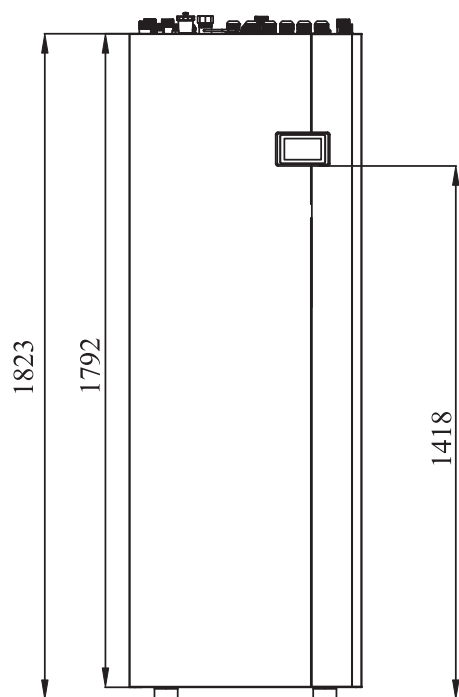

## 2. Overview of the Units

### 2.2.Outlines and Dimensions

#### 【 Outdoor unit 】

NP6-V7-S

Unit:mm

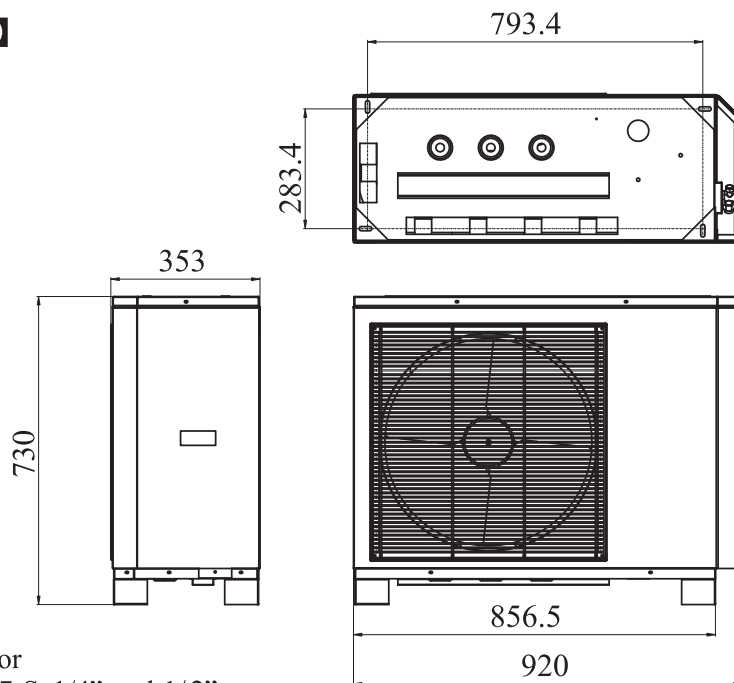

Refrigerant connector  
dimension:NPH6-V7-S: 1/4" and 1/2"

NP9-V7-S

Unit:mm

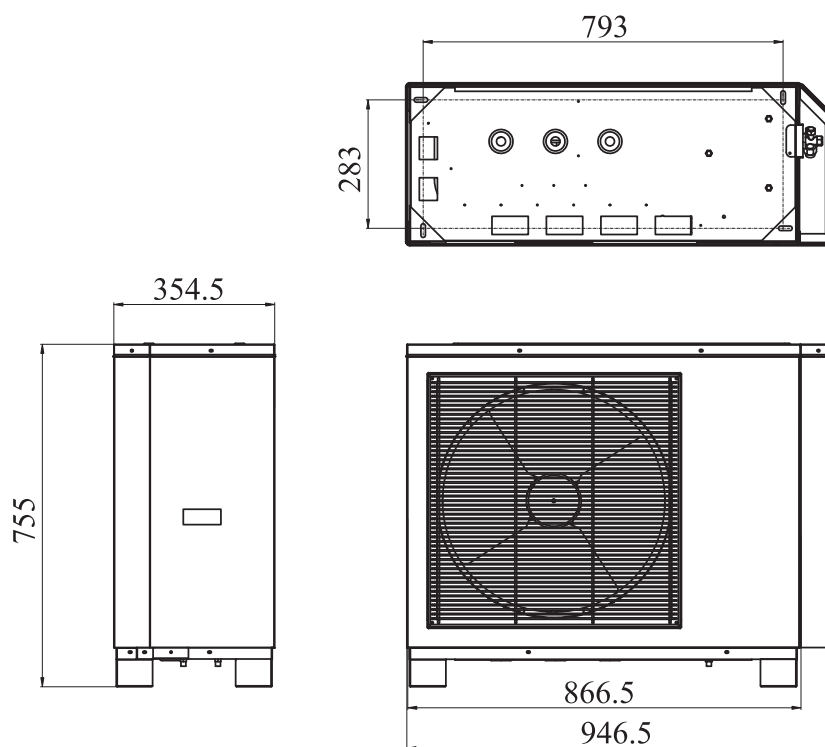

Refrigerant connector  
dimension:NPH9-V7-S: 3/8" and 1/2"

## 2. Overview of the Units

### 2.2.Outlines and Dimensions

#### 【 Outdoor unit 】

NP11-V7-S

Unit:mm

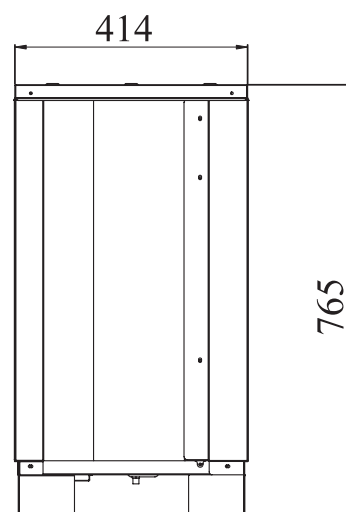
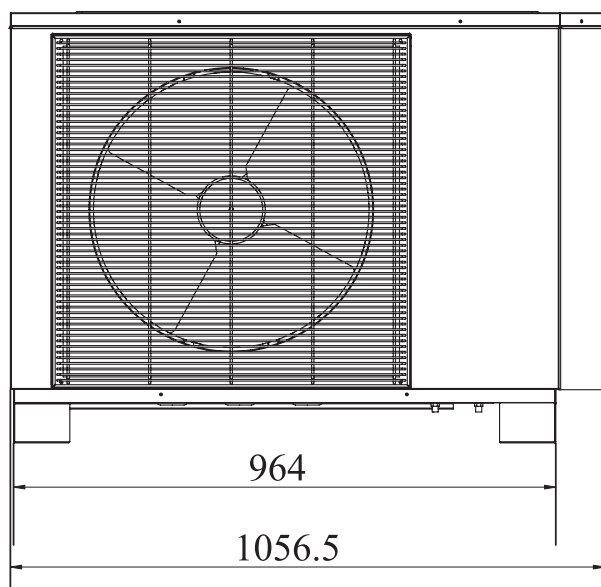
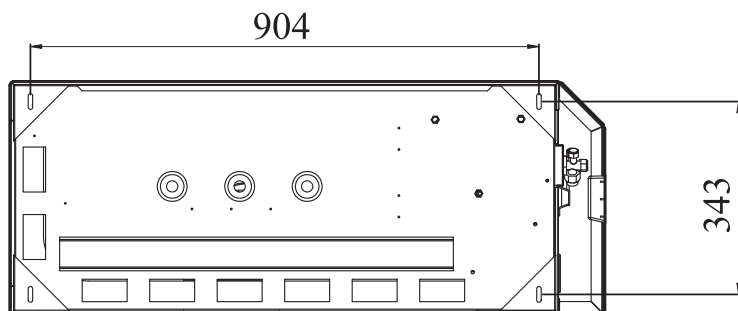

Liquid pipe O.D. 3/8"

Gas pipe O.D. 1/2"

## 2. Overview of the Units

### 2.2.Outlines and Dimensions

#### 【 Outdoor unit 】

NP13-V7-S

Unit:mm

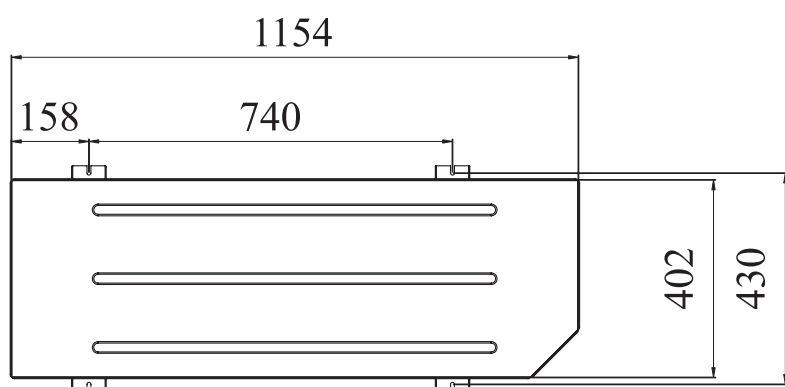
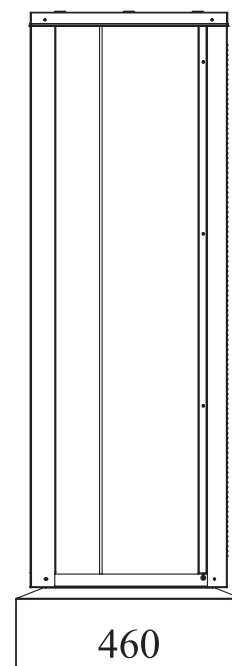
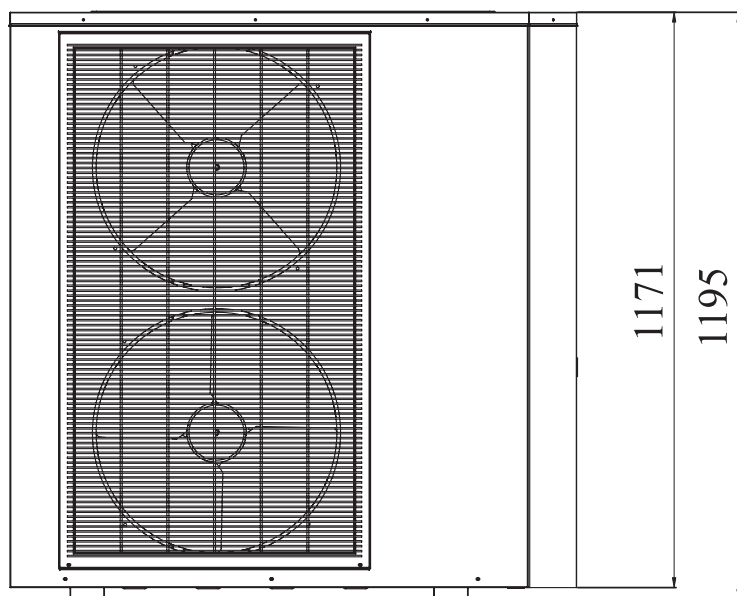

Refrigerant connector

Liquid pipe O.D. 3/8"

Gas pipe O.D. 5/8"

## 2. Overview of the Units

### 2.3. Exploded view

Outdoor — NP6/9/11-V7-S

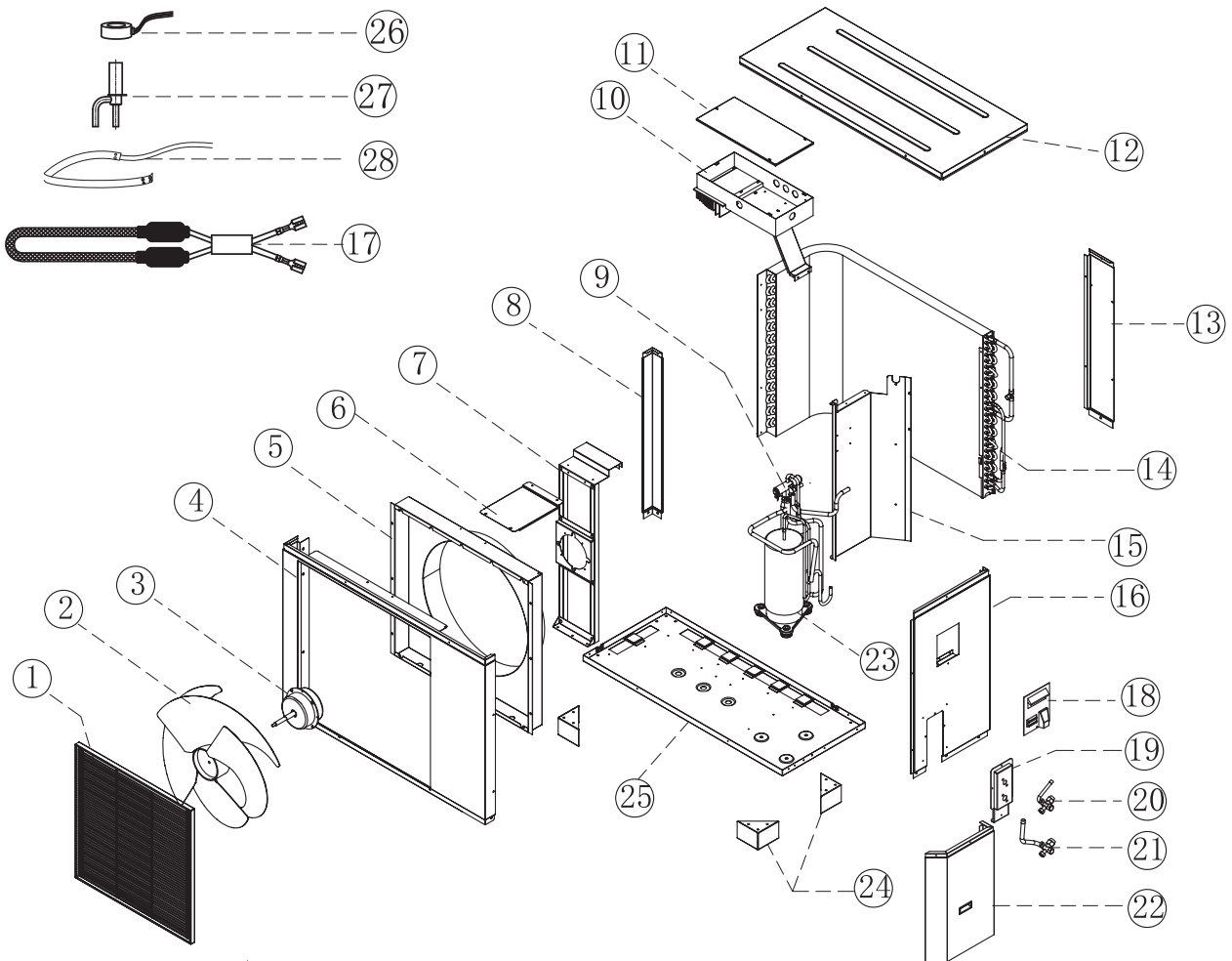

NO	Name	NO	Name	NO	Name
1	Decorative panel	11	Electric box cover	20	1/4" Valve-NP6-V7-S
2	Outdoor fan	12	Top panel		3/8" Valve-NP9/11-V7-S
3	Outdoor motor	13	Back panel	21	1/2" Valve
4	Front panel	14	Condenser	22	Side decorative panel
5	Air guide	15	Bulkhead	23	Compressor
6	Fixture	16	Right plate	24	Feet
7	Motor bracket	17	Condebser heater	25	Bottom plate
8	Column support	18	Big handle	26	Eev coil
9	Four-way valve	19	Bulkhead	27	Electrical expansion valve
10	Electrical box			28	Compressor heater



## 2. Overview of the Units

### 2.3. Exploded view

Outdoor — NP13-V7-S

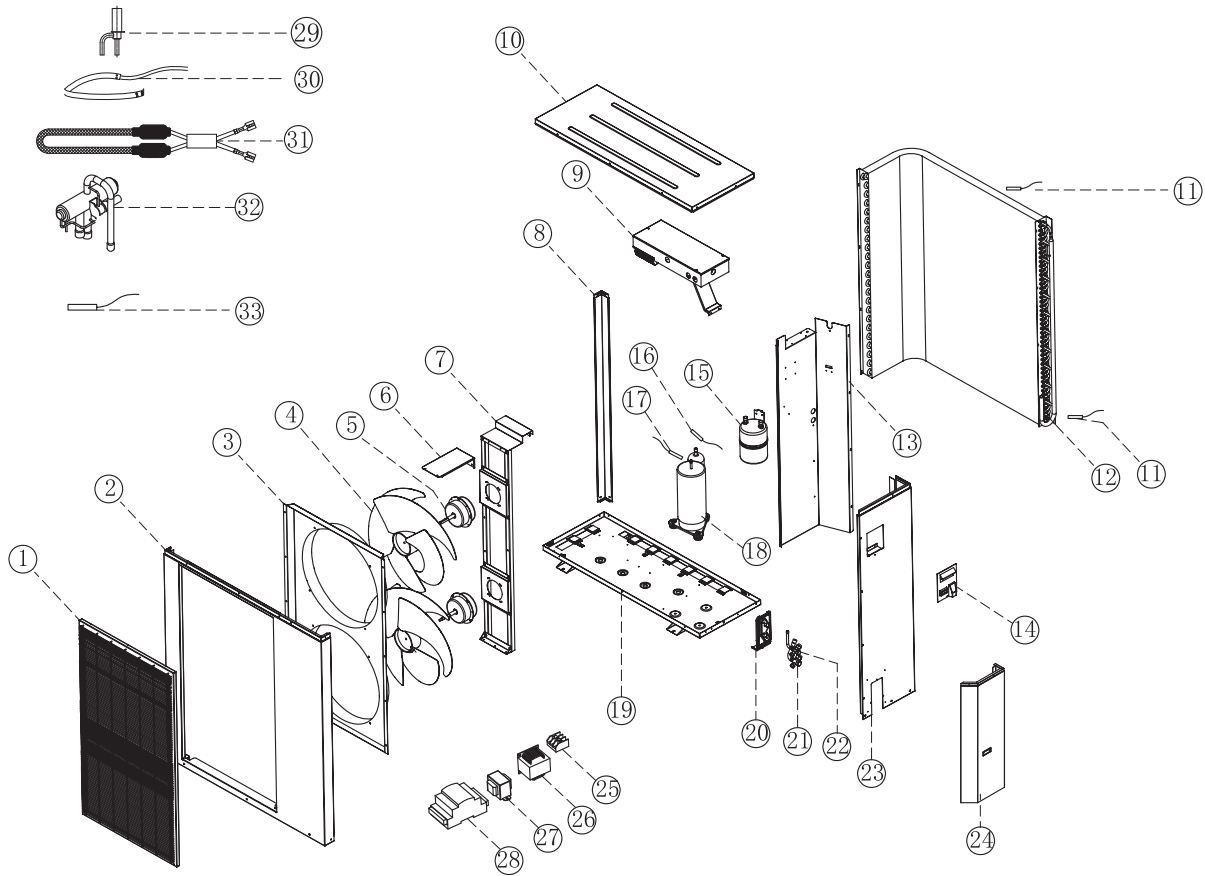

NO	Name	NO	Name	NO	Name
1	Decorative panel	12	Condenser	23	Side panel
2	Front panel	13	Bulkhead	24	Side decorative panel
3	Air guide	14	Handle	25	Terminal block
4	Outdoor fan	15	Sperator	26	PFC transducer
5	Outdoor motor	16	Suction temperature sensor	27	Transformer
6	Fixture	17	Compressor discharge temperature sensor	28	EEV controller
7	Motor bracket			29	Electronic expansion valve
8	Column support	18	Compressor	30	Crankcase heater
9	Controller	19	Bottom plate	31	Condenser heater
10	Top panel	20	Valve plate	32	4-Way valve
11	Coil and ambient temperature sensor	21	5/8" Valve	33	EEV temperature sensor
		22	3/8" Valve		

### 3. Assembly Configurations - Flowchart

## Locate the Configuration that Meets Your Needs

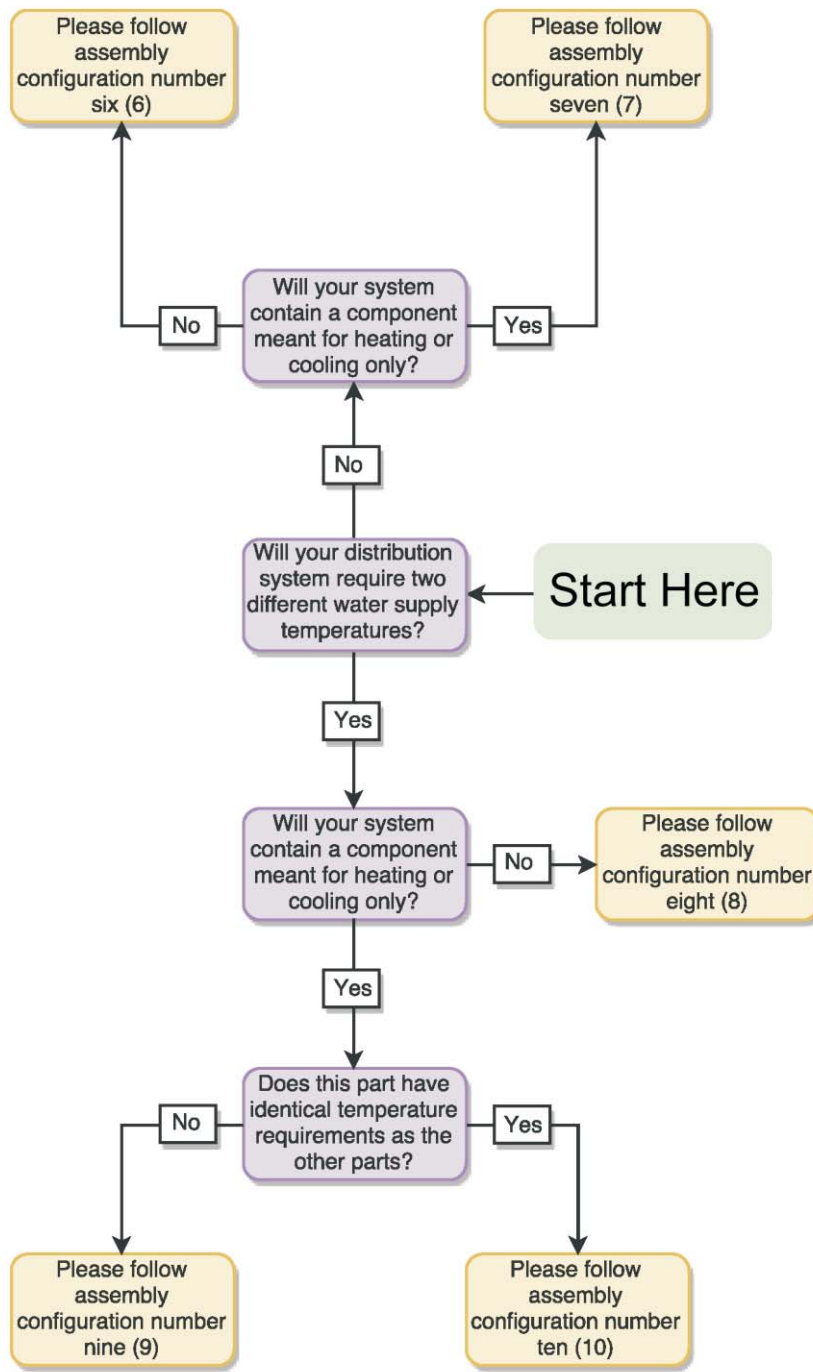

Follow the flowchart on the right in order to locate which of the assembly configuration matches the needs of the end user, each of which contains specific assembly and wiring diagrams, with software instructions.

Beginning from the green “Start Here” bubble, follow the appropriate arrows to each question, which are dependent on the needs of the user.

The corresponding assembly instructions will be found by turning to the page number in the end bubble.

**Note:** *The instructions in this section are meant to achieve the minimum requirements for successful system operation only.*

*For more in-depth settings explanations, please refer to the user’s manual.*

### 3. Assembly Configurations – Drawing 1

Please ensure that the configuration matches the assembly drawing depicted on the right for a one temperature zone setup that includes domestic hot water.

*Note: Refer to the next page for wiring and software operation instructions.*

Name	Symbol	Name	Symbol
Temp. Sensor		Water pump	
Safety valve Kit		Mixing valve	
Ball valve		Motorized valve	
Water filter		Expansion tank	
Air purging valve			

*Note: Dotted lines mean "able to be controlled by the Heat Pump". distribution systems.*

*Notice: The Fan Coil Unit, Floor Heating System, and Radiator are placeholder distribution systems only and can be substituted by any other appropriate*

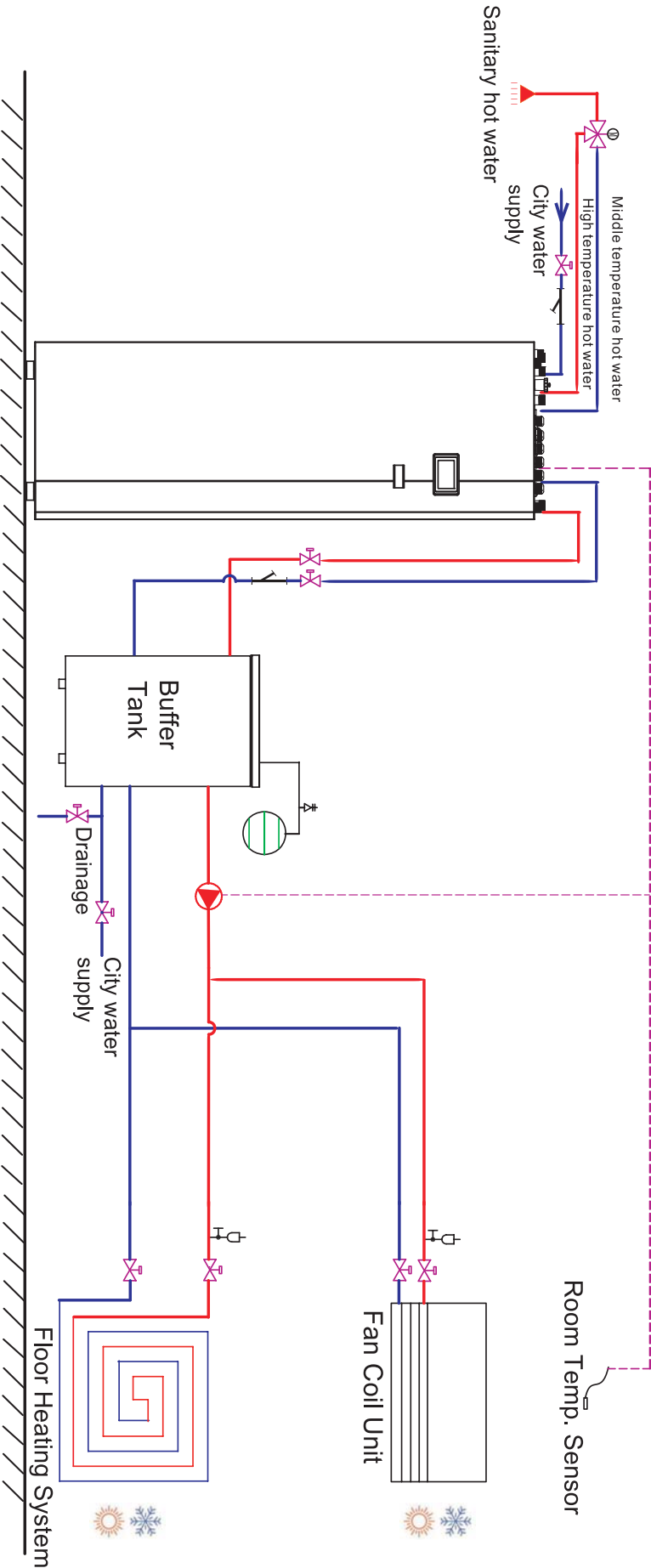

One Temperature Zone, without DHW

# 3. Assembly Configurations – Drawing 1

## Assembly 1: Wiring Diagram

To achieve successful operation at a minimum, ensure the ports below are properly connected.

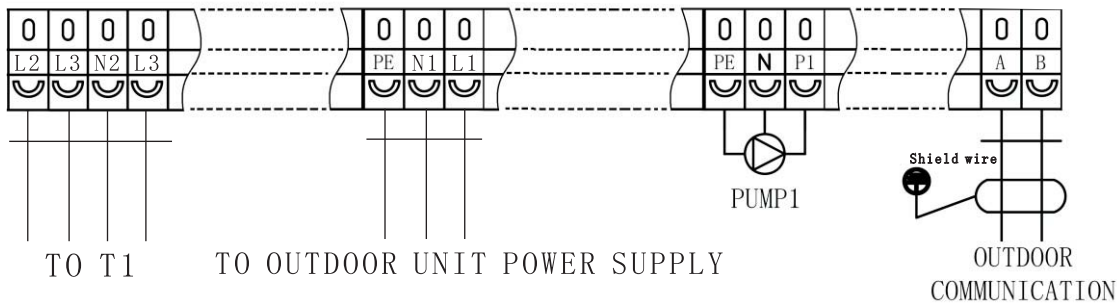

## Software: Basic Settings

1. Set the needed working modes of the unit via the menu

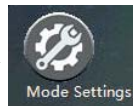

2. Temperature configuration options for Heating/Cooling circuit 1 are found under



**H.** Configuring the set water heating temperatures:

**H.1.** Setting a heating curve:



Ambient Temp. 1	-25°C	Water Temp. A/Ambient Temp. 1	40°C
Ambient Temp. 2	-15°C	Water Temp. B/Ambient Temp. 2	37°C
Ambient Temp. 3	-5°C	Water Temp. C/Ambient Temp. 3	33°C
Ambient Temp. 4	5°C	Water Temp. D/Ambient Temp. 4	29°C
Ambient Temp. 5	10°C	Water Temp. E/Ambient Temp. 5	25°C

**H.2.** If no heating curve is desired:

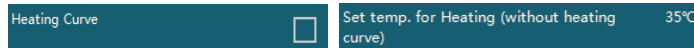

**C.** Configuring the set water cooling temperature (if applicable):

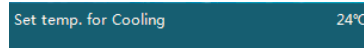

If cooling function is desired, ensure these sections are configured.

3. Locate and activate the buffer tank and appropriate pumps under

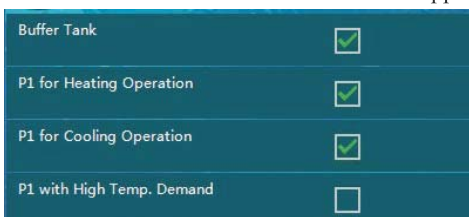
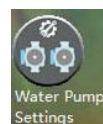

### 3. Assembly Configurations – Drawing 1

---

#### Software: Basic Settings (continued)

4. Double-check to ensure that the Domestic Hot Water option is enabled under

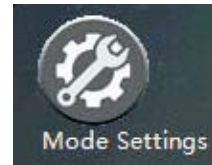

5. Configure the desired setpoint for water temperature (default set to 50°C):



### 3. Assembly Configurations – Drawing 2

Please ensure that the configuration matches the assembly drawing depicted on the right for a one temperature zone setup that includes domestic hot water; that also includes a component circuit capable of heating or cooling only, through the use of a two-way motorized valve.

*Note: For the cooling-only or heating-only circuit, a motorized two-way valve can be connected to the unit, to cut the water supply during heating or cooling operation.*

*Refer to the next page for wiring and software operation instructions.*

Name	Symbol	Name	Symbol
Temp. Sensor		Water pump	
Safety valve Kit		Mixing valve	
Ball valve		Motorized valve	
Water filter		Expansion tank	
Air purging valve			

Note: Dotted lines mean "able to be controlled by the Heat Pump".

*Notice: The Fan Coil Unit, Floor Heating System, and Radiator are placeholder distribution systems only and can be substituted by any other appropriate distribution systems.*

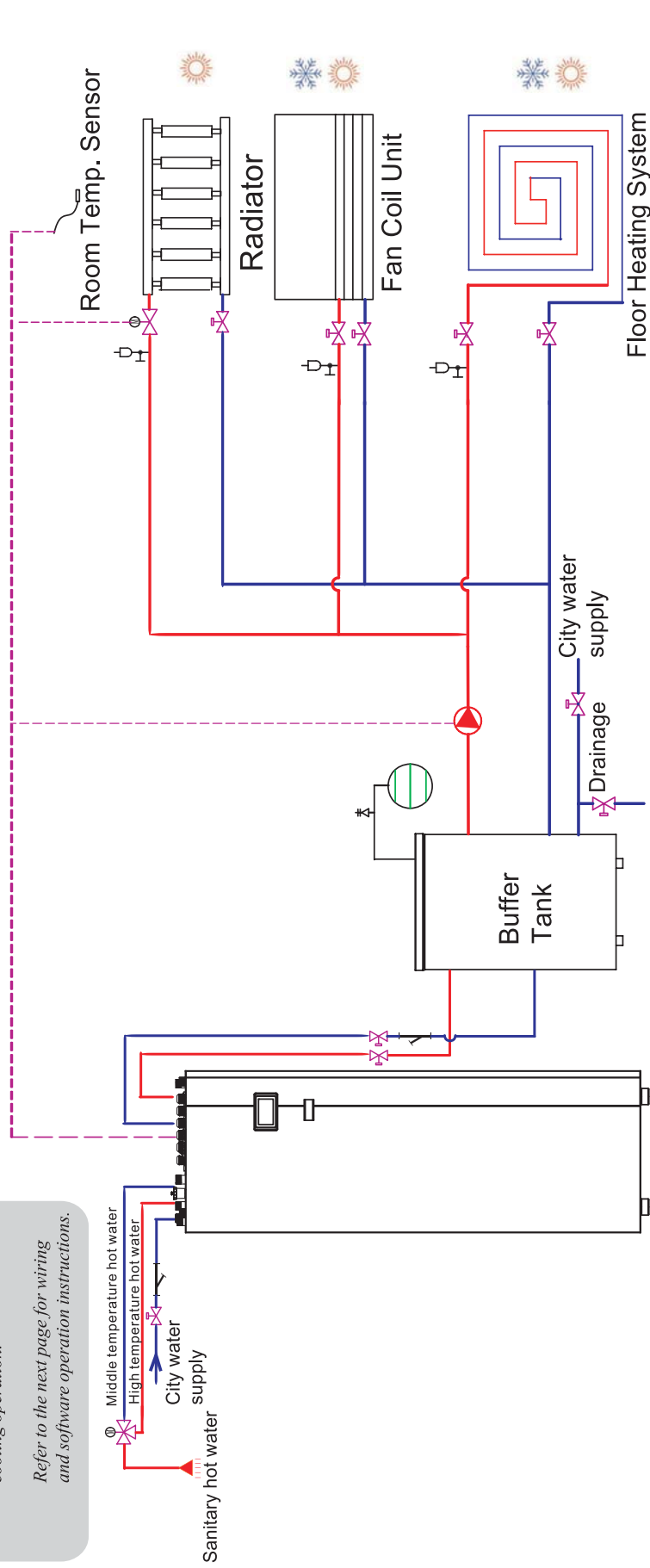

**One Temperature Zone, without DHW, with a heating-only (or cooling-only) circuit, by usage of a motorized 2-way valve**

# 3. Assembly Configurations – Drawing 2

## Assembly 2: Wiring Diagram

To achieve successful operation at a minimum, ensure the ports below are properly connected.

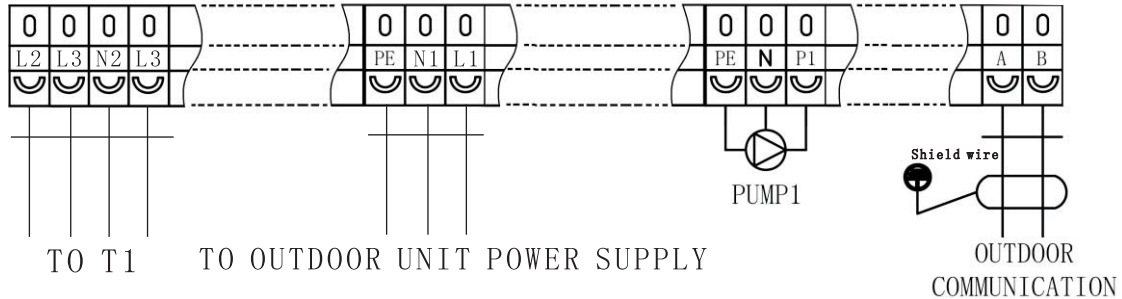

## Software: Basic Settings

1. Set the needed working modes of the unit via the menu

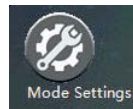

Sanitary Hot Water	<input type="checkbox"/>
Heating	<input checked="" type="checkbox"/>
Cooling	<input checked="" type="checkbox"/>

2. Temperature configuration options for Heating/Cooling circuit 1 are found under



**H.** Configuring the set water heating temperatures:

**H.1.** Setting a heating curve:

Heating Curve	<input checked="" type="checkbox"/>
---------------	-------------------------------------

Ambient Temp. 1	-25°C
Ambient Temp. 2	-15°C
Ambient Temp. 3	-5°C
Ambient Temp. 4	5°C
Ambient Temp. 5	10°C

Water Temp. A/Ambient Temp. 1	40°C
Water Temp. B/Ambient Temp. 2	37°C
Water Temp. C/Ambient Temp. 3	33°C
Water Temp. D/Ambient Temp. 4	29°C
Water Temp. E/Ambient Temp. 5	25°C

**H.2.** If no heating curve is desired:

Heating Curve	<input type="checkbox"/>	Set temp. for Heating (without heating curve)	35°C
---------------	--------------------------	---	------

**C.** Configuring the set water cooling temperature (if applicable):

Set temp. for Cooling	24°C
-----------------------	------

If cooling function is desired, ensure these sections are configured.

3. Locate and activate the buffer tank and appropriate pumps under



Buffer Tank	<input checked="" type="checkbox"/>
P1 for Heating Operation	<input checked="" type="checkbox"/>
P1 for Cooling Operation	<input checked="" type="checkbox"/>
P1 with High Temp. Demand	<input type="checkbox"/>

### 3. Assembly Configurations – Drawing 2

#### Software: Basic Settings (continued)

4. The location of the configuration for heating-only or cooling-only system is under

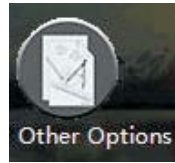

5. Double-check to ensure that the Domestic Hot Water option is enabled under



6. Configure the desired setpoint for water temperature (default set to 50°C):





### 3. Assembly Configurations – Drawing 3

Please ensure that the configuration matches the assembly drawing depicted on the right for a two temperature zone setup that includes domestic hot water.

*Note: Refer to the next page for wiring and software operation instructions.*

Name	Symbol	Name	Symbol
Temp. Sensor		Water pump	
Safety valve Kit		Mixing valve	
Ball valve		Motorized valve	
Water filter		Expansion tank	
Air purging valve			

Note: Dotted lines mean "able to be controlled by the Heat Pump".

*Notice: The Fan Coil Unit, Floor Heating System, and Radiator are placeholder distribution systems only and can be substituted by any other appropriate distribution systems.*

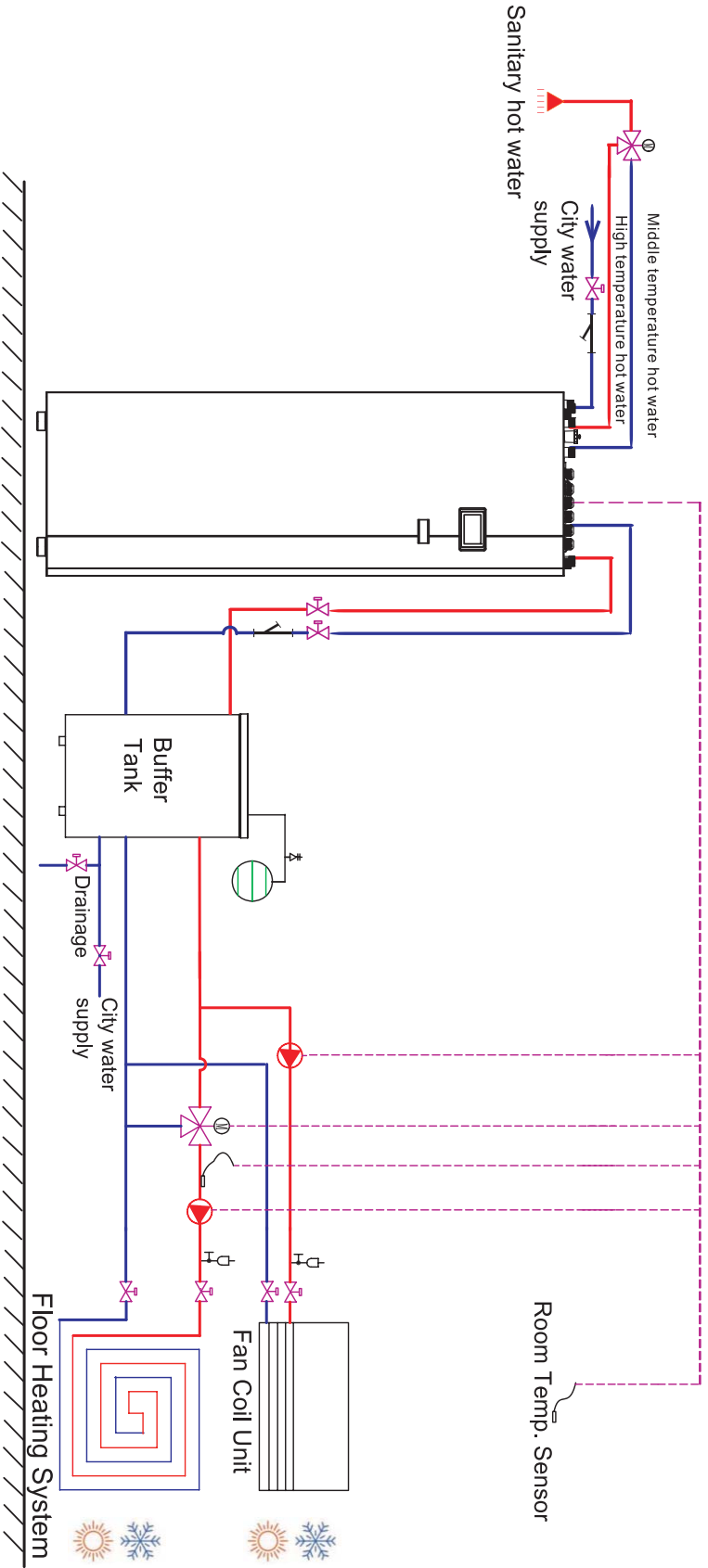

Two Temperature Zone, with DHW

# 3. Assembly Configurations – Drawing 3

## Assembly 3: Wiring Diagram

To achieve successful operation at a minimum, ensure the ports below are properly connected.

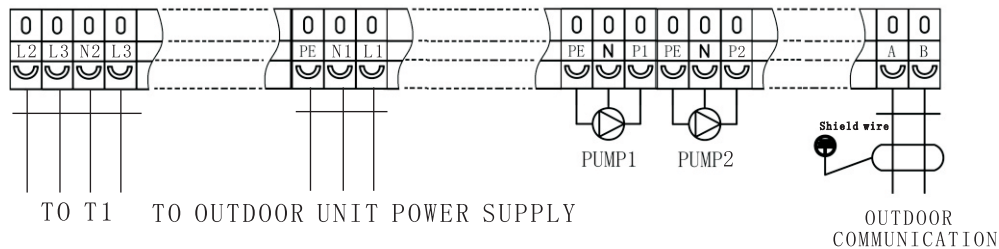

For connection for mixing valve 2, please refer to the appendix A (on page 85-86) of this manual for more information.

## Software: Basic Settings

1. Set the needed working modes of the unit via the menu

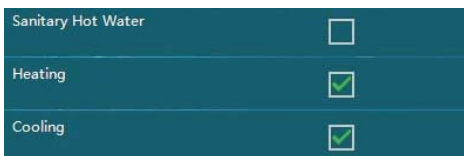
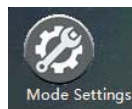

2. Temperature configuration options for Heating/Cooling circuit 1 are found under



**H.** Configuring the set water heating temperatures:

**H.1.** Setting a heating curve:



Ambient Temp. 1	-25°C
Ambient Temp. 2	-15°C
Ambient Temp. 3	-5°C
Ambient Temp. 4	5°C
Ambient Temp. 5	10°C

Water Temp. A/Ambient Temp. 1	40°C
Water Temp. B/Ambient Temp. 2	37°C
Water Temp. C/Ambient Temp. 3	33°C
Water Temp. D/Ambient Temp. 4	29°C
Water Temp. E/Ambient Temp. 5	25°C

**H.2.** If no heating curve is desired:

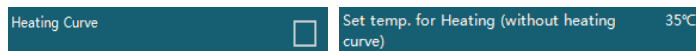

**C.** Configuring the set water cooling temperature (if applicable):

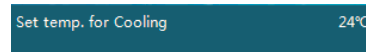

If cooling function is desired, ensure these sections are configured.

3. Locate and activate the buffer tank and appropriate pumps under

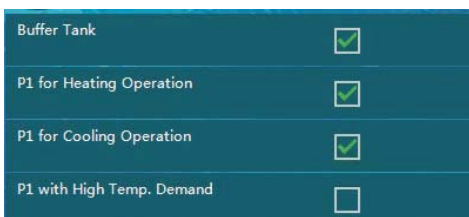

# 3. Assembly Configurations – Drawing 3

## Software: Basic Settings (continued)

3.(cont.) Configure the water pump to operate for heating or cooling:

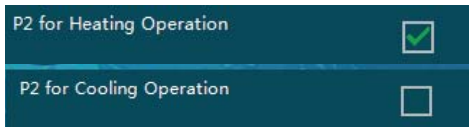

4. Temperature configuration options for Heating/Cooling circuit 2 are found under

Please activate entire Heating/Cooling circuit 2 setting



H. configuring the set water heating temperatures:



H.1. Setting a heating curve:



Water Temp. A/Ambient Temp. 1	40°C
Water Temp. B/Ambient Temp. 2	37°C
Water Temp. C/Ambient Temp. 3	33°C
Water Temp. D/Ambient Temp. 4	29°C
Water Temp. E/Ambient Temp. 5	25°C

H.2. If no heating curve is desired:

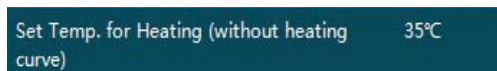

C. Configuring the set water cooling temperature (if applicable):



4.1. Activate the mixing valve to manage the second circuit:



*Note: This pair of settings will interpret “Heating/Cooling Circuit 2 as the low demand distribution system, requiring a lower set temperature for heating and higher set temperature for cooling.*

5. Double-check to ensure that the Domestic Hot Water option is enabled under

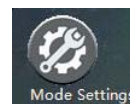

6. Configure the desired setpoint for water temperature (default set to 50°C):



Dependent on whether cooling is needed

### 3. Assembly Configurations – Drawing 4

Please ensure that the configuration matches the assembly drawing depicted on the right for a two temperature zone setup that includes domestic hot water, also that includes a component circuit capable of heating or cooling only, through the use of a two-way motorized valve.

*Note: For the cooling-only or heating-only circuit, a motorized two-way valve can be connected to the unit, to cut the water supply during heating or cooling operation.*

*Refer to the next page for wiring and software operation instructions.*

*Notice: The Fan Coil Unit, Floor Heating System, and Radiator are placeholder distribution systems only and can be substituted by any other appropriate distribution systems.*

Name	Symbol	Name	Symbol
Temp. Sensor		Water pump	
Safety valve Kit		Mixing valve	
Ball valve		Motorized valve	
Water filter		Expansion tank	
Air purging valve			

Note: Dotted lines mean "able to be controlled by the Heat Pump".

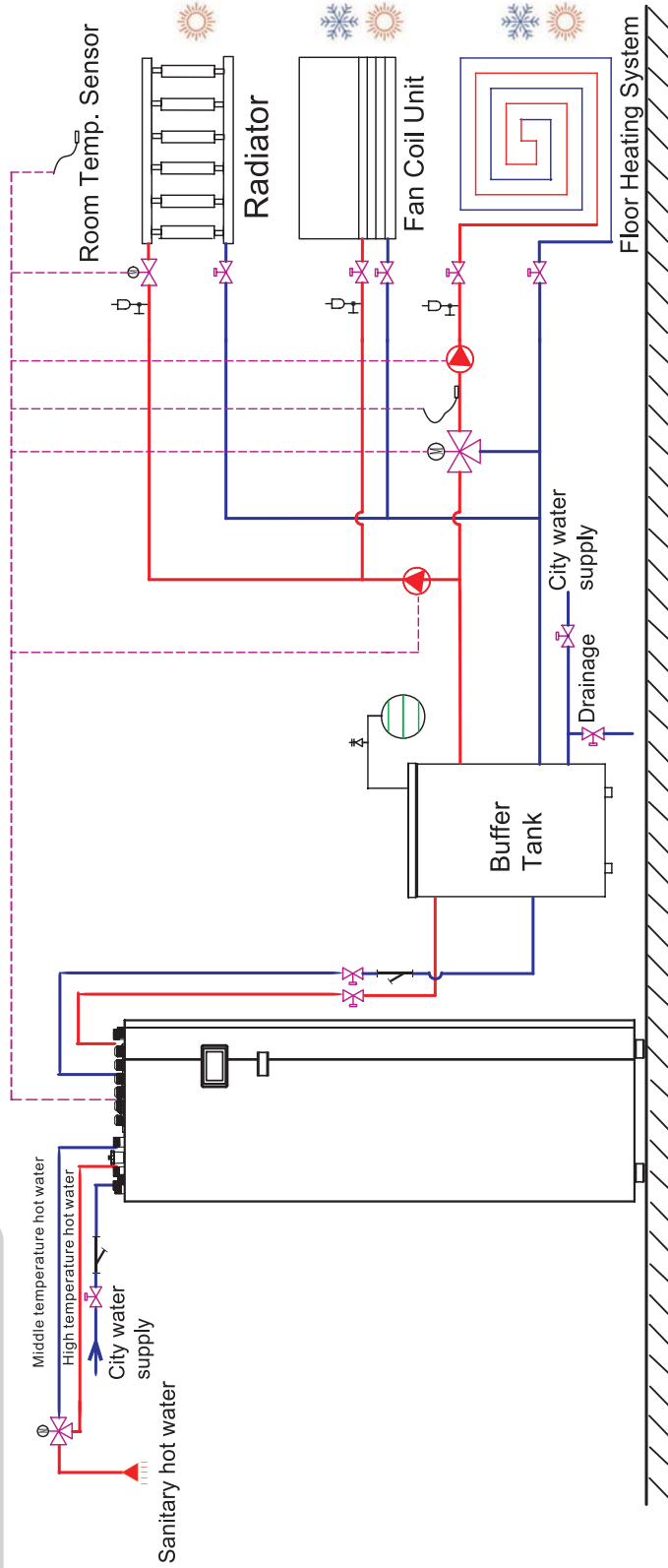

Two Temperature Zones , without DHW, with a heating-only (or cooling-only) circuit, by usage of a motorized 2-way valve

# 3. Assembly Configurations – Drawing 4

## Assembly 4: Wiring Diagram

To achieve successful operation at a minimum, ensure the ports below are properly connected.

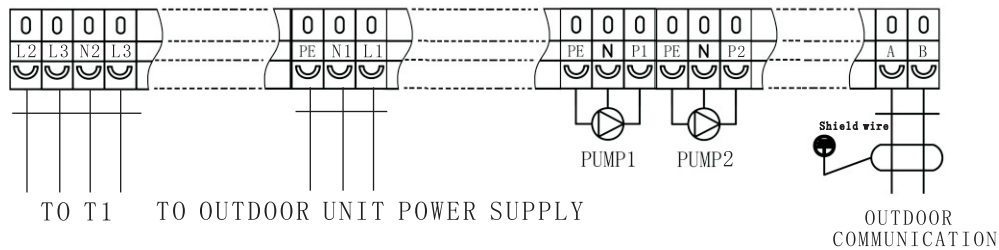

For connection for mixing valve 2, please refer to the appendix A (on page 85-86) of this manual for more information.

## Software: Basic Settings

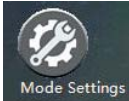
1. Set the needed working modes of the unit via the menu  Mode Settings

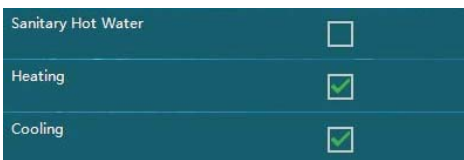

2. Temperature configuration options for Heating/Cooling circuit 1 are found under 

**H.** Configuring the set water heating temperatures:

**H.1.** Setting a heating curve:



Ambient Temp. 1	-25°C	Water Temp. A/Ambient Temp. 1	40°C
Ambient Temp. 2	-15°C	Water Temp. B/Ambient Temp. 2	37°C
Ambient Temp. 3	-5°C	Water Temp. C/Ambient Temp. 3	33°C
Ambient Temp. 4	5°C	Water Temp. D/Ambient Temp. 4	29°C
Ambient Temp. 5	10°C	Water Temp. E/Ambient Temp. 5	25°C

**H.2.** If no heating curve is desired:

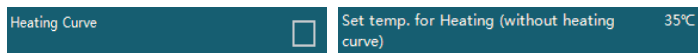

**C.** Configuring the set water cooling temperature (if applicable):

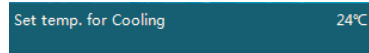

If cooling function is desired, ensure these sections are configured.

3. Locate and activate the buffer tank and appropriate pumps under  Water Pump Settings

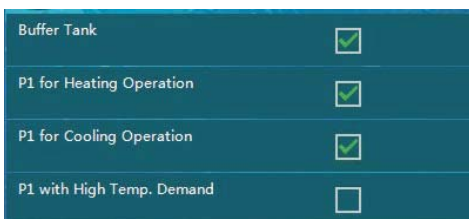

# 3. Assembly Configurations – Drawing 4

## Software: Basic Settings (continued)

3.(cont.) Configure the water pump to operate for heating or cooling:

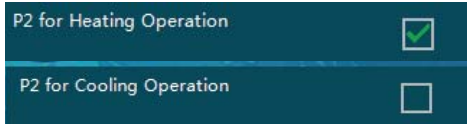

4. The location of the configuration for heating-only or cooling-only system is under

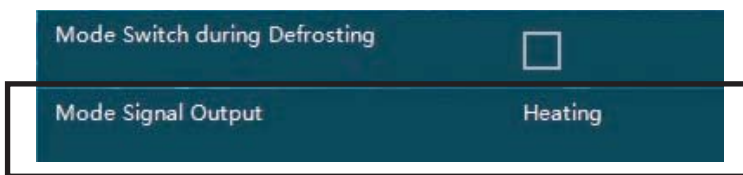
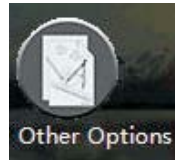

5. Temperature configuration options for Heating/Cooling circuit 2 are found under



H. configuring the set water heating temperatures:

H.1. Setting a heating curve:



Water Temp. A/Ambient Temp. 1	40°C
Water Temp. B/Ambient Temp. 2	37°C
Water Temp. C/Ambient Temp. 3	33°C
Water Temp. D/Ambient Temp. 4	29°C
Water Temp. E/Ambient Temp. 5	25°C

H.2. If no heating curve is desired:



Set Temp. for Heating (without heating curve)	35°C
---	------

C. Configuring the set water cooling temperature (if applicable):



5.1. Activate the mixing valve to manage the second circuit:



*Note: This pair of settings will interpret “Heating/Cooling Circuit 2 as the low demand distribution system, requiring a lower set temperature for heating and higher set temperature for cooling.*

6. Double-check to ensure that the Domestic Hot Water option is enabled under

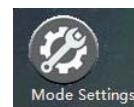

7. Configure the desired setpoint for water temperature (default set to 50°C):



Dependent on whether cooling is needed

### 3. Assembly Configurations – Drawing 5

Please ensure that the configuration matches the assembly drawing depicted on the right for a two temperature zone setup that includes domestic hot water, also that utilizes the secondary pump for a heating-only operation.

*Note: For the heating-only circuit, a motorized two-way valve can be connected to the unit, to cut the water supply during heating operation.*

*Refer to the next page for wiring and software operation instructions.*

Name	Symbol	Name	Symbol
Temp. Sensor		Water pump	
Safety valve Kit		Mixing valve	
Ball valve		Motorized valve	
Water filter		Expansion tank	
Air purging valve			

*Note: Dotted lines mean "able to be controlled by the Heat Pump".*

*Notice : The Fan Coil Unit, Floor Heating System, and Radiator are placeholder distribution systems only and can be substituted by any other appropriate distribution systems.*

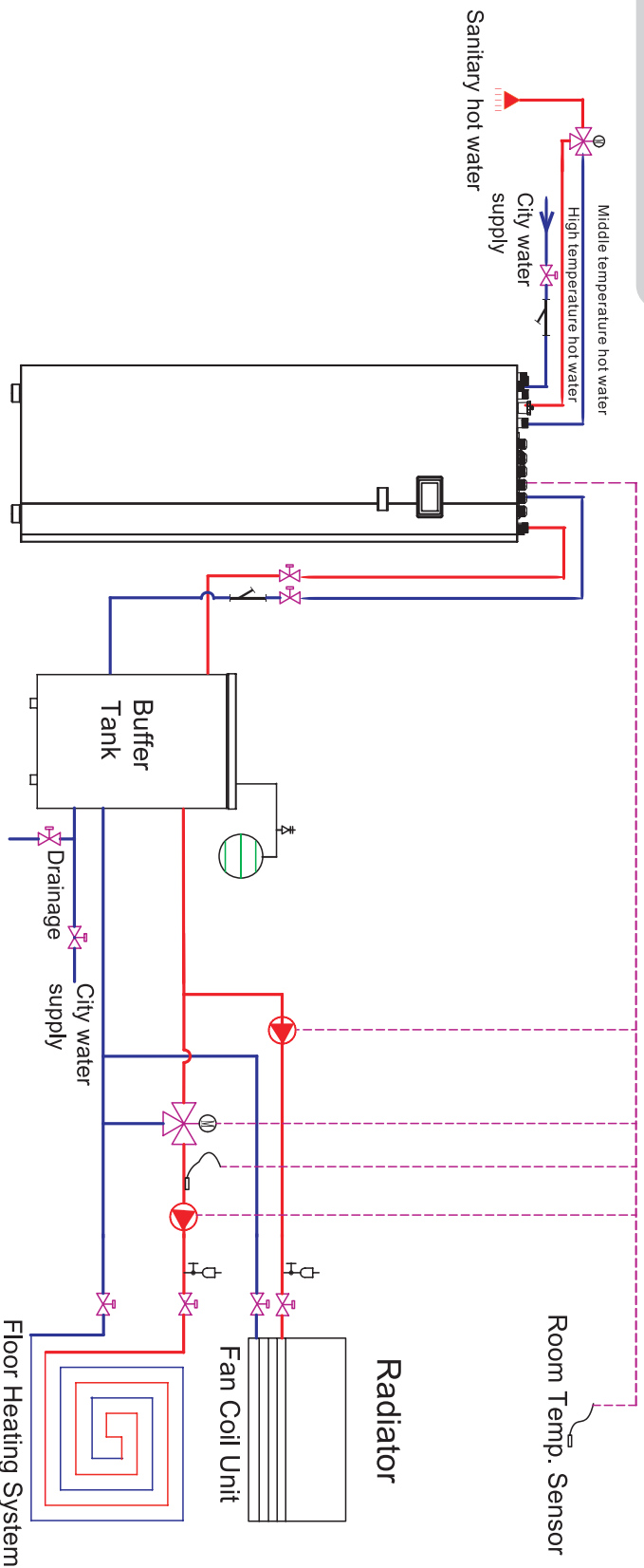

**Two Temperature Zones , without DHW, with a heating-only circuit, by setting the secondary pump to heating-only**

# 3. Assembly Configurations – Drawing 5

## Assembly 5: Wiring Diagram

To achieve successful operation at a minimum, ensure the ports below are properly connected.

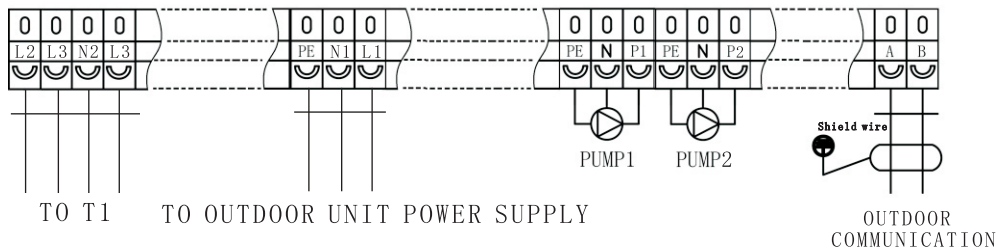

For connection for mixing valve 2, please refer to the appendix A (on page 85-86) of this manual for more information.

## Software: Basic Settings

1. Set the needed working modes of the unit via the menu

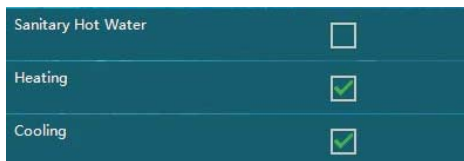
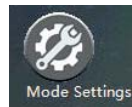

2. Temperature configuration options for Heating/Cooling circuit 1 are found under

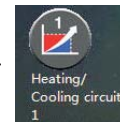

H. Configuring the set water heating temperatures:

H.1. Setting a heating curve:



Ambient Temp. 1	-25°C
Ambient Temp. 2	-15°C
Ambient Temp. 3	-5°C
Ambient Temp. 4	5°C
Ambient Temp. 5	10°C

Water Temp. A/Ambient Temp. 1	40°C
Water Temp. B/Ambient Temp. 2	37°C
Water Temp. C/Ambient Temp. 3	33°C
Water Temp. D/Ambient Temp. 4	29°C
Water Temp. E/Ambient Temp. 5	25°C

H.2. If no heating curve is desired:

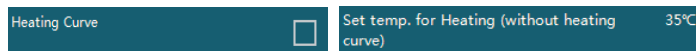

C. Configuring the set water cooling temperature (if applicable):

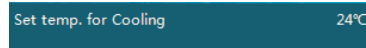

If cooling function is desired, ensure these sections are configured.

3. Locate and activate the buffer tank and appropriate pumps under

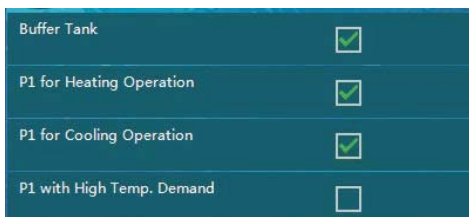
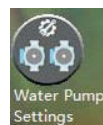



# 3. Assembly Configurations – Drawing 5

## Software: Basic Settings (continued)

3.(cont.) Configure the water pump to operate for heating or cooling:



4. Temperature configuration options for Heating/Cooling circuit 2 are found under

H. configuring the set water heating temperatures:

H.1. Setting a heating curve:



Water Temp. A/Ambient Temp. 1	40°C
Water Temp. B/Ambient Temp. 2	37°C
Water Temp. C/Ambient Temp. 3	33°C
Water Temp. D/Ambient Temp. 4	29°C
Water Temp. E/Ambient Temp. 5	25°C

H.2. If no heating curve is desired:

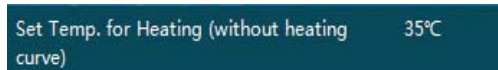

C. Configuring the set water cooling temperature (if applicable):



4.1. Activate the mixing valve to manage the second circuit:



*Note: This pair of settings will interpret “Heating/Cooling Circuit 2 as the low demand distribution system, requiring a lower set temperature for heating and higher set temperature for cooling.*

5. Double-check to ensure that the Domestic Hot Water option is enabled under

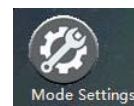

6. Configure the desired setpoint for water temperature (default set to 50°C):



# 4. Installation Walkthrough

---

## 4.1. Sanitary Hot Water Configurations

---

### 4.1.1. Note about the Heating/Cooling Distribution System

Users are heavily recommended to install a buffer tank into the chosen configuration, especially when the method of hot water distribution is below 20L/W of water volume.

The buffer tank should be installed between the heat pump and the distribution system, in order to:

- Ensure the heat pump unit provides a stable and sufficient water flow rate.
- Minimize fluctuation of the system's heating/cooling load by storing unused heat.
- Increase capacity of water volume distribution, which helps ensure proper heat pump operation.

If the method of hot water distribution is capable of dispersing a large enough flow rate, a buffer tank can be excluded from installation into the configuration. If so, please move the cooling/heating temperature sensor (TC, #10 on page 1) to the water return pipe, so that fluctuations of water temperature due to compressor speed changes are minimized.

# 4. Installation Walkthrough

## 4.2. Heating and Cooling Circuits

This heat pump unit is capable of controlling two completely different heating and cooling circuits, as shown in the following images.

Configuring the temperatures for circuits 1 and 2 can be done via the “Heating and Cooling Circuit” menus.

If only one circuit is desired, then “Heating and Cooling Circuit 2” can be set to OFF.

### 4.2.1. Heating & Cooling Circuits

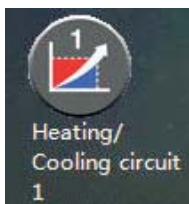

Heating/Cooling Stops Based on Water $\Delta T$	2°C
Heating/Cooling Restarts Based on Water $\Delta T$	2°C
$\Delta T$ Compressor Speed-reduction	2°C
Set temp. for Cooling	24°C
Heating Curve	<input checked="" type="checkbox"/>



Heatingcooling Circuit 2	<input type="checkbox"/>
Set temp. For Cooling	24°C
Set Temp. for Heating (without heating curve)	35°C
Mixing Valve	<input type="checkbox"/>
Heating Curve	<input checked="" type="checkbox"/>

The basic understanding of these settings is found under your the software section of your particular assembly walkthrough in Chapter 3. A more detailed explanation can be located in the user’s manual.

# 4. Installation Walkthrough

## 4.2. Heating and Cooling Circuits

### 4.2.2. Mixing Valves MV1 and MV2

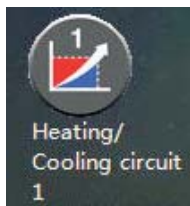

If the system water temperature may be higher (or lower) than the temperatures needed for circuit 1 (or circuit 2) in a heating or cooling operation, then a mixing valve can be added to the circuit, and connected to the MV1 (or MV2) port on the indoor unit.

The unit will control the mixing valve, continuously mix the supply, and return the water of the circuit to have its temperature read via the TV1 (or TV2) until the value set under the above menus is achieved.

TV1 and/or TV2 should be activated on the installer's level via the "Heating and Cooling Circuit" menu.

Note: A mixing valve is needed, if:

- The system has two circuits that require different water temperatures. The heat pump will have to take the higher/lower (depending on whether heating/cooling) settings of the two circuits as the set temperature for the heat pump. The mixing valve ensures correct water temperature circulation in this instance.
- The system has other heating sources inside that are not controlled by the heat pump. In this case, the actual water temperature may exceed the set temperature.

## 4. Installation Walkthrough

### 4.2. Heating and Cooling Circuits

#### 4.2.3. Circulation Pump Control



Buffer Tank	<input type="checkbox"/>
P1 for Heating Operation	<input type="checkbox"/>
P1 for Cooling Operation	<input type="checkbox"/>
P1 with High Temp. Demand	<input type="checkbox"/>
P2 for Heating Operation	<input type="checkbox"/>
P2 for Cooling Operation	<input type="checkbox"/>
P2 with High Temp. Demand	<input type="checkbox"/>

*Note: P1 is circulation pump 1, P2 is pump 2*

- “Buffer Tank” should be checked if one is installed between the heat pump and distribution system.
- “P1/P2 for Heating/Cooling Operation” sets that circuit’s pump to work for heating or cooling.

If “Buffer Tank” is NOT checkmarked, both P1 and P2 will only work when the compressor is working in the same mode that the pump is set to. So, if P1 is set to “P1 for Heating Operation”, P1 will activate ONLY when the compressor is working in heating mode. If P1 is checkmarked for both “Heating” and “Cooling” operations, then P1 will be ON when the compressor is working in both heating and cooling modes. The pump stops when switched to DHW mode, or after the set temperature is reached.

If “Buffer Tank” IS checkmarked, both P1 and P2 will work as long as there is demand from the distribution system, as per the pump setting. The following must also be fulfilled:

- Actual temperature in the buffer tank (detected via TC) is equal or above 20°C (in heating)
- Actual temperature in the buffer tank (detected via TC) is equal or below 23°C (in cooling)

Even if the unit is working in DHW mode, or the set temperature is reached, the circulation pump will start to work as long as there are heating/cooling demands, and TC is fulfilled as per the above.

- “P1/P2 with High Temp. Demand” sets P1/P2 to automatically stop if the signal for “high demand” is off. For more information regarding this setting, please refer to part D on page 62.

**NOTE:** It is very important to place the temperature sensor (TR) in a central location with good circulation, with no hot or cold equipment nearby, in a column or interior wall, or somewhere similar.

## 4. Installation Walkthrough

---

### 4.3. Indoor Unit Installation

---

#### 4.3.1. Choosing an installation location

- A. The indoor unit can be located in a room, corridor, balcony, garage or warehouse.
- B. Indoor unit should be placed on flat and solid ground.
- C. The unit is recommended to be put in a space close to water supply, and drainage.
- D. The outdoor and indoor unit should be placed close, to save the copper tube as well as the energy.
- E. The indoor unit shall be placed in dry and well-ventilated environment.
- F. Indoor unit mustn't be installed in an environment where volatile, corrosive or flammable liquid or gas exists.
- G. During the movement, please be careful to keep the unit vertically. If the unit is tilted by  $30^\circ$ , it may fall down and cause damage to itself or the porter.
- H. Don't expose the operation panel under direct sunshine.
- I. Enough space should be left around the indoor unit for further maintenance.

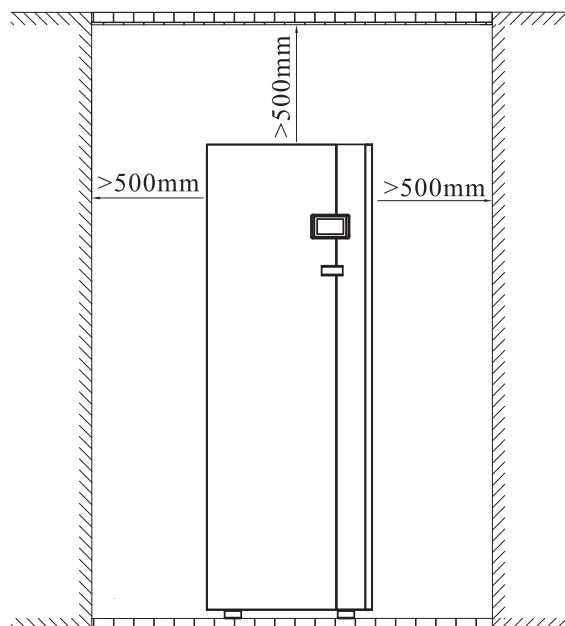

## 4. Installation Walkthrough

### 4.4. Outdoor Unit Installation

#### 4.4.1. Choosing an installation location

- A. The outdoor unit can be located in a room, corridor, balcony, and roof or hanged on the wall.
- B. Please don't install outdoor unit close to bedroom or living room, because there is some noise when it's running.
- C. The outdoor unit shall be placed in dry and well-ventilated environment.
- D. Outdoor unit mustn't be installed in an environment where volatile, corrosive or flammable liquid or gas exists.
- E. Please cover a protecting roof over the outdoor unit, lest ice or snow blocks the air inlet. Shield the unit from direct sunshine, rain or snow, but never cover the unit which will cause the bad ventilation.
- F. Please ensure there is drainage system around the location, to drain the condensed water under defrosting mode.
- G. Please don't install the indoor and outdoor unit in damp locations, otherwise it may cause short-circuit or corrosion of some components. The unit should be free from corrosive and moisture surrounding. Otherwise the lifetime of the unit might be shortened.
- H. When installing the unit in harsh climatic conditions, sub-zero temperatures, snow, humidity area, please raise the unit above the ground by about 20cm.
- I. When installing the unit, tilt it by 1cm/cm to left side of the unit (see from front), for better water drainage.
- J. Outdoor unit should be placed on flat and solid ground. When installing the outdoor unit, please ensure enough space around the outdoor unit, for better ventilation and maintenance. Please refer to the illustration below.

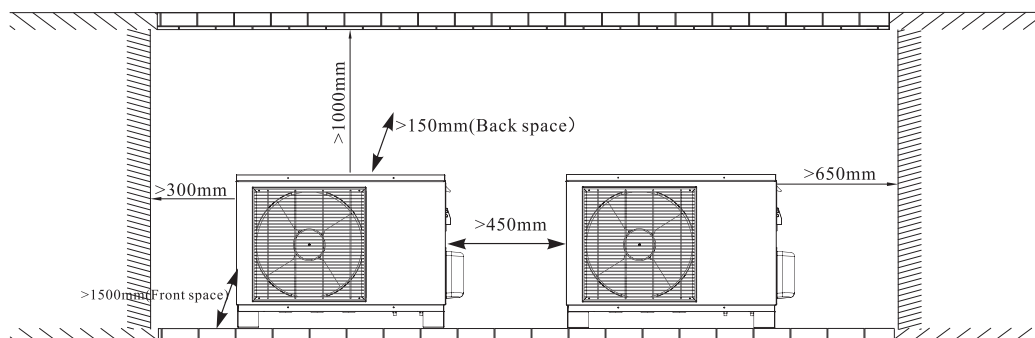

# 4. Installation Walkthrough

## 4.4. Outdoor Unit Installation



Please add rubber absorber under the outdoor unit, to reduce the vibration.

### 【A. On a concrete stand】

1. The unit must be located on a flat, solid, preferably cemented surface.
2. When installing the unit, introduce a tilt of 1cm/m for rain water evacuation.
3. When installing the unit in harsh climatic conditions, sub-zero temperature, snow, humidity..., it is recommended to raise the unit off the ground by about 50cm.
4. It is recommended to have a base with following size for these units:
5. Rubber vibration absorbing mountings are recommended.
6. When sitting he unit, take care to leave sufficient free space all around it for carrying out maintenance.

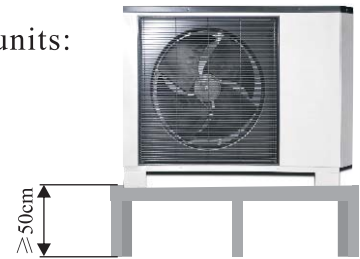

### 【B. On brackets on the wall】

**A: If needs to hang the outdoor unit on the wall, please do as followings:**

1. Adjust the location of the wall brackets according to the distance between two feet of the unit.
2. Fix the brackets on the wall with expansion bolts.
3. Place the outdoor unit on the brackets. A Vibration absorbers are recommended to reduce vibration and noise.
4. Fix the unit to the bracket.

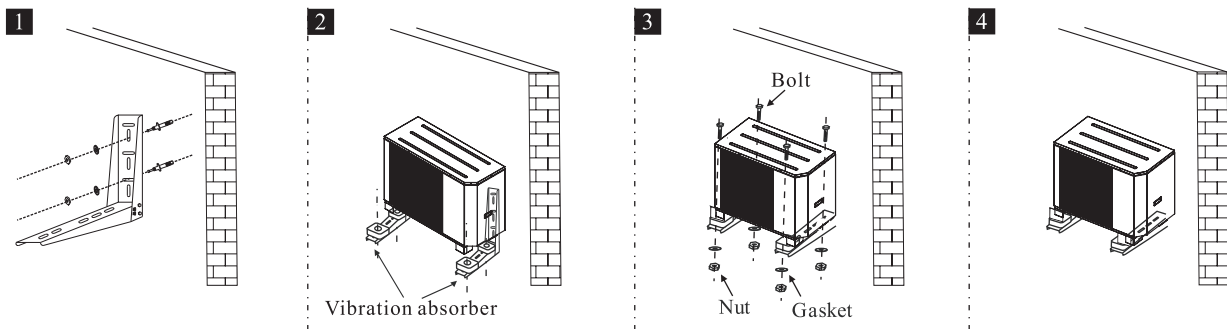

The refrigerant piping and signal cable between indoor and outdoor unit should go through the wall by using a wall sleeve.

The hole should lean to outside a little bit ( $\geq 8$  degrees), to avoid rain water or condensate water flow back to the indoor.

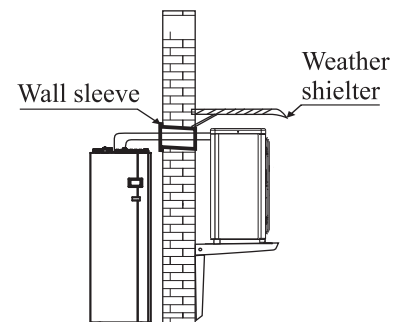



## 4. Installation Walkthrough

### 4.5. Refrigerant pipe connection

Please take the refrigerant pipe and accessories from the carton box of piping kit.

When insulating the refrigerant pipe, please insulate each pipe separately (refer to figure 1 below), don't insulate the refrigerant pipes together (refer to figure 2 below).

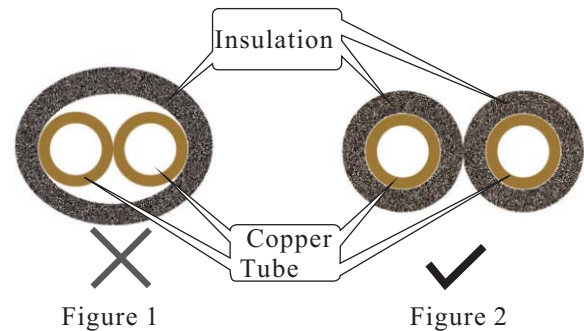

#### 【Precaution】

The installation kit consists of two gas-filled pipes, drainage hose, sealant, diffusion tape, 2 pipe insulation sections, cable ties and electrical cable with connector arrangement for connecting the indoor unit to the outdoor unit.

Note that the drainage hose must only be used for air/air heat pumps and therefore not for air/water.

**NOTE: Do not remove the plastic plugs on the pipe sections until the installation of the pipes has begun.**



#### 【Holes】



Start by drilling with the detection drill to check that there are no obstacles in the way and that the hole on the outside will be correct. Holding the detection drill sideways, feel inside the wall if there is anything in the way around the detection drill's hole.

If there is nothing obstructing the detection drill, the wall bracket can be fitted and the hole (about 80mm) drilled. Check the dimension or the supplied wall bushing.

Set the drill at low speed to prevent a build-up of heat and the saw teeth becoming “sticky”. It is also a good idea to pre-drill with a 12-15mm bit so that any chips in the wall can run out.

# 4. Installation Walkthrough

## 4.6. Refrigerant Pipework

### 4.6.1. Amount of Refrigerant:

For all units, the refrigerant included inside is sufficient for up to 5 meter long piping kits. If the piping is beyond 5m, it is necessary to add 40g of refrigerant per additional meter. It is recommended to keep the length of the refrigerant piping to under 12m.

*Ex. If the pipe is 9m in length,  $4 \times 40g = 160g$  of refrigerant will need to be added.*

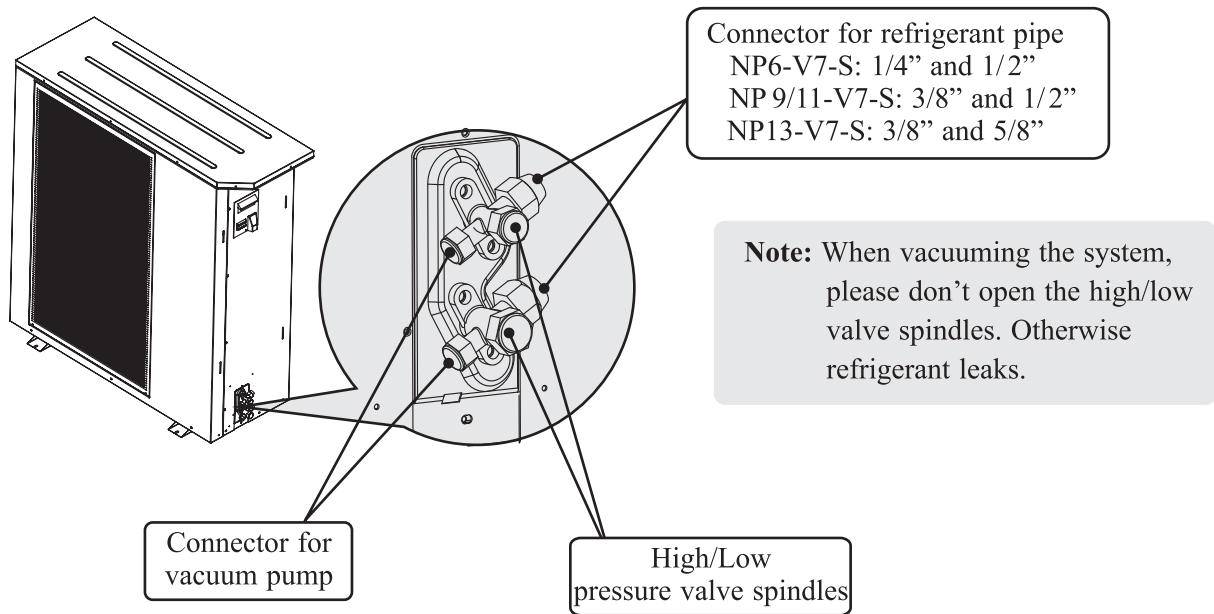

### 4.6.2. Precautions

Because the refrigerant pipe transfers heat to the entire system, any insufficient vacuuming and/or leakage of the refrigeration system will lead to decreased performance. Therefore, please ensure the following:

- Select a high quality refrigerant pipe that conforms to the pressure standards of Refrigerant R410A.
- Insulate the pipe before connecting it.
- Avoid bending/deforming the refrigerant pipe as much as possible.
- Ensure the inside of the pipe is completely dry, to avoid trapping moisture in the pipeline.
- Any walls or separators between the indoor and outdoor unit should have a wall sleeve fixed to the hole, which the installer should drill in order to accommodate the refrigerant pipe.
- Do not insulate the refrigerant pipes together. (Fig.1)  
Each pipe requires its own insulation. (Fig.2)

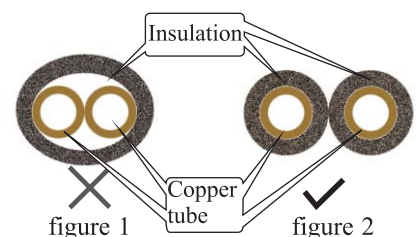

## 4. Installation Walkthrough

### 4.6. Refrigerant Pipework

#### IMPORTANT:

The radius of pipe bends cannot be less than 15 cm.  
Use a cardboard/paper template to verify it is above this.  
Run the power cord through the pipe as it bends.  
Create the bends carefully and gradually.  
Do not bend the pipe against an edge.

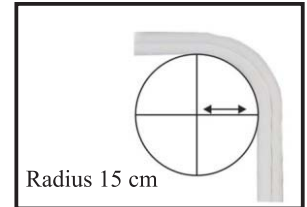

#### 4.6.3. Installation:

Please connect the refrigerant pipe as follows:

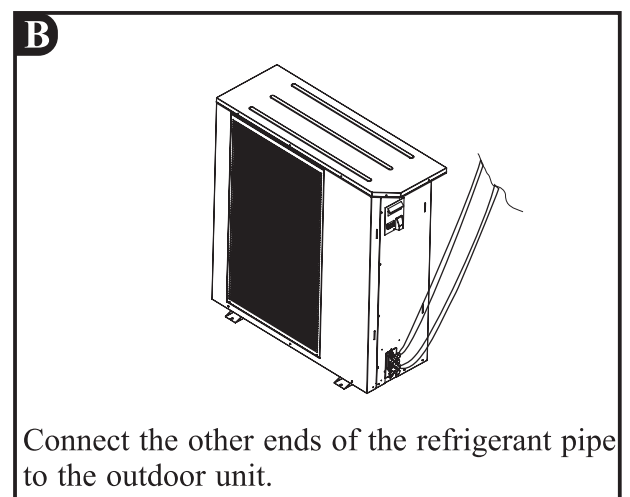
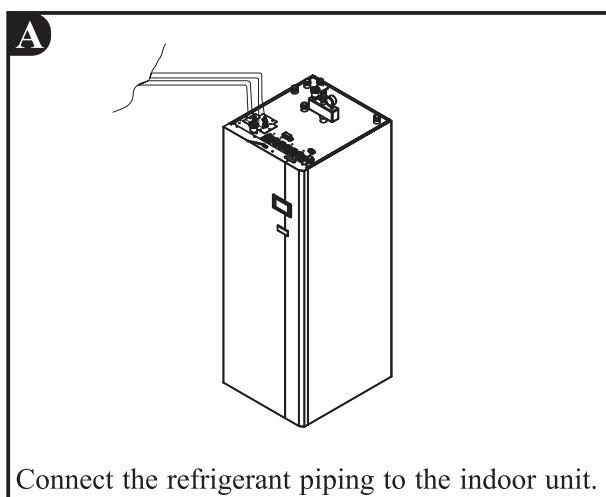
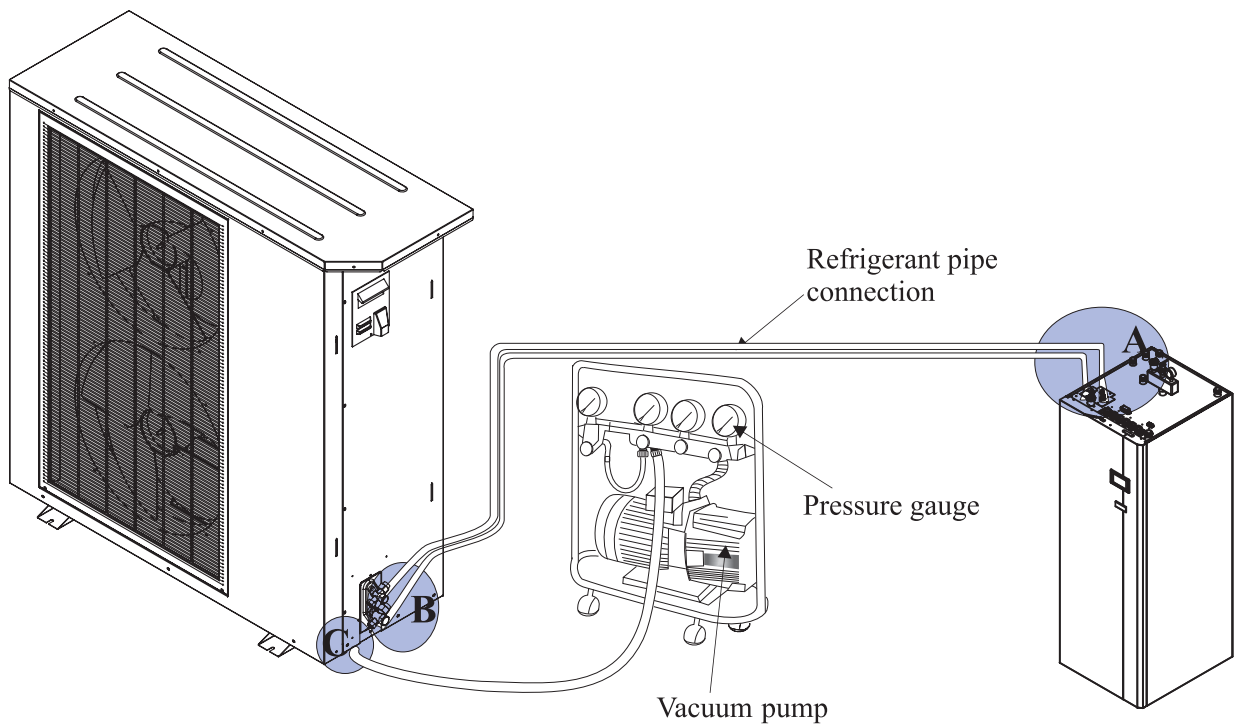

## 4. Installation Walkthrough

### 4.6. Refrigerant Pipework

**C**

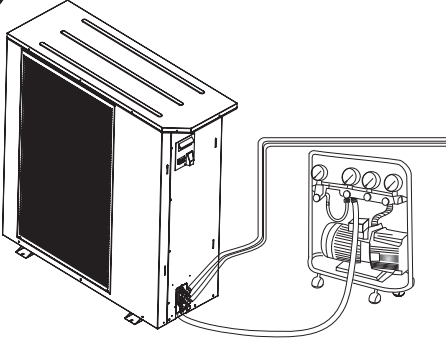

Prepare a vacuum pump and a pressure gauge, connect one end of the pressure gauge to the vacuum pump. The other end should be connected to high pressure refrigerant port on the outdoor unit.

---

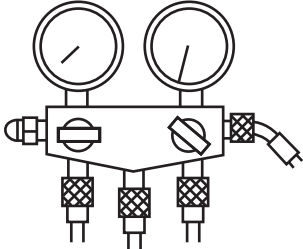

Open the pressure gauge, and set the vacuum pump to run for 10 minutes. Once the pressure gauge shows a negative pressure reading, turn off the vacuum pump and the gauge.

Disconnect the tube ends of pressure gauge, and install the copper nut back to the high pressure connection port.

---

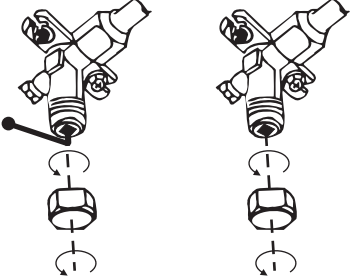

Remove the copper nut from the gas and liquid valves. open the valves all the way using a hexagon spanner.

---

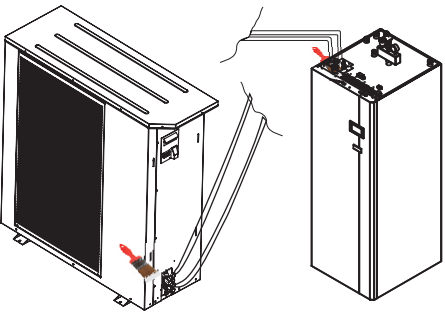

Check for any leakage using a detector, or soapy water. If no leakage is detected, retighten the copper nuts back onto the valves.

# 4. Installation Walkthrough













## 4.6. Refrigerant Pipework

### CLEANING THE MAGNETIC/DIRT FILTER CALEFFI

The Filter should be cleaned at the beginning and of the heating season.

**Note:**

First heating season, it is recommended to clean the Filter first time after 1 month working of the heat pump and until the end of the first heating season every 2 months. If there is still much dirt collecting in the filter, repeat this procedure until the system is free of excessive dirt.

<p>1. Turn OFF the heat pump with the ON/OFF button and wait for min 5 minute before proceeding to the next step.</p> 	<p>2. Close the hand valves.</p> 	<p>3. Remove the Magnet and wait for 5 minutes before proceeding to the next step.</p> 
<p>4. Drain the dirty water.</p> 	<p>5. Remove the Dirt Filter.</p> 	<p>6. Remove the strainer from the holder.</p> 
<p>7. Clean the strainer with warm water under a tap.</p> 	<p>8. Reassemble the filter and close the draining valve.</p> 	<p>9. Open the hand valve on the low side.</p> 
<p>10. Purge the air from the Filter.</p> 	<p>11. Retrieve the Magnet.</p> 	<p>12. Open the upper hand valve.</p> 
<p>13. Start the Heat Pump with the ON/OFF button.</p> 		

## 4. Installation Walkthrough

### 4.6. Refrigerant Pipework

REFRIGERANT PIPING LENGTH				CONNECTIONS
HEAT PUMP	FACTORY LOAD	MAXIMUM LENGTH	ADD	
6KW	5 meters	15 meters	40g/m	1/4"and 1/2"
9KW	5 meters	20 meters	40g/m	3/8"and 1/2"
11KW	5 meters	20 meters	40g/m	3/8"and 1/2"
13KW	12 meters	20 meters	40g/m	3/8"and 5/8"

For each meter that is longer than the factory load, you must add additional refrigerant according to the table above.

#### HEIGHT DIFFERENCE BETWEEN INDOOR AND OUTDOOR UNIT

Height difference between outdoor and indoor unit

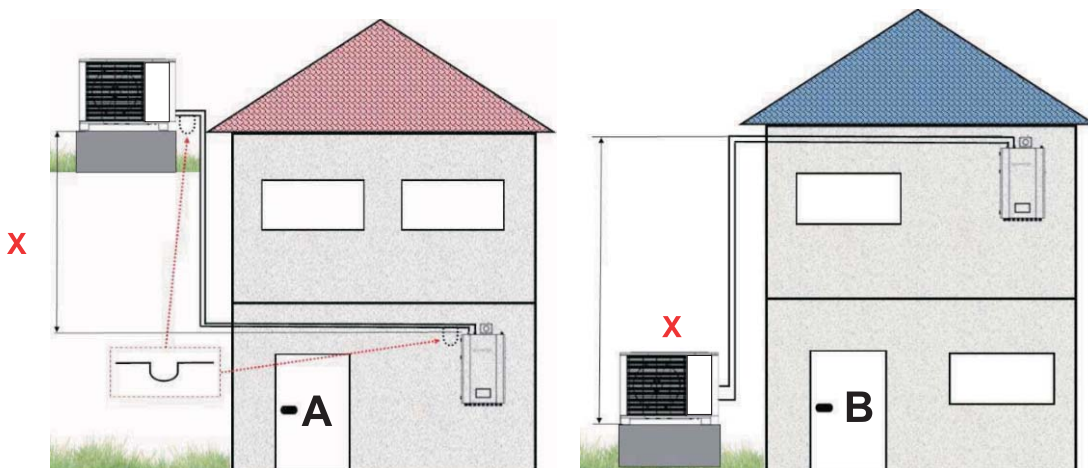

#### A) Outdoor unit is **above** Indoor unit

Maximum height difference is **X** m.

Total pipe length distance can be maximum **Y** m. In case of 7m(**X**) height distance between indoor and outdoor unit, horizontal pipe distance can be maximum 5m (**Z**).

**In that case is obligatory to integrate 1 siphon.**

#### B) Outdoor unit is **below** Indoor unit

Maximum height difference is **X** m.

Total pipe length distance can be maximum **Y** m. In case of 5m height distance between indoor and outdoor unit, horizontal pipe distance can be maximum 7m (**Z**).

## 4. Installation Walkthrough

### 4.6. Refrigerant Pipework

#### OUTDOOR UNIT IS ABOVE INDOOR UNIT (House A)

Model name	Maximum pipe length (Y)	Outdoor unit is <b>above</b> Indoor unit max. height difference <b>X</b> [m]	Maximum horizontal pipe distance/number of siphons (Z)
6KW	15 meters	7m	11meters / 2 siphons
9/11KW	20 meters	7m	15meters / 2 siphons
13KW	20 meters	7m	15meters / 2 siphons

#### OUTDOOR UNIT IS BELOW INDOOR UNIT (House B)

Model name	Maximum pipe length (Y)	Outdoor unit is <b>below</b> Indoor unit max. height difference <b>X</b> [m]	Maximum horizontal pipe distance/number of siphons (Z)
6KW	15 meters	5 m	15 meters / 0 siphons
9/11KW	20 meters	5 m	20 meters / 0 siphons
13KW	20 meters	5 m	20 meters / 0 siphons

## 4. Installation Walkthrough

### 4.7. Water pipe connection

After installing the unit, please connect the water inlet and outlet pipe according to the local instructions. Please carefully select and operate the water pipe.

After connection, the water piping should be pressure tested, cleaned before use.

#### 【Water filling】

##### ▲ One way valve:

One way valve must be installed to water filling connector, to avoid back-flow of water when water supply stops or water pressure not enough (one way valve is packed with the unit).

##### ▲ Filter:

A filter (20 mesh/cm<sup>2</sup>) should be installed at the water inlet of water tank as well as that of indoor unit, to avoid sediments and guarantee water quality.

##### ▲ Ball valve:

A ball valve is recommend for easy operation of drainage or filter cleaning.

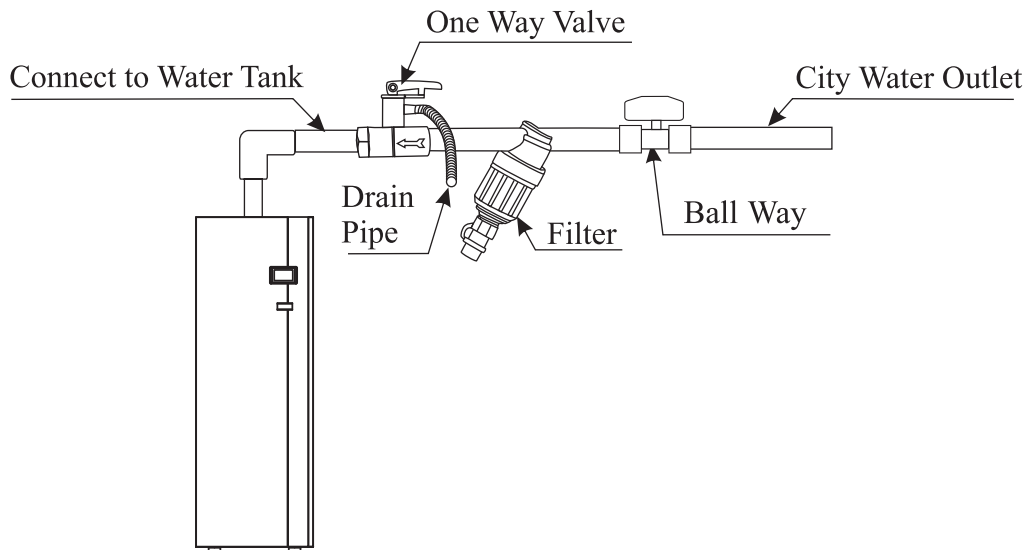

#### 【Connect of drainage pipe】

When the tank need to be drained, please do as per following instruction:

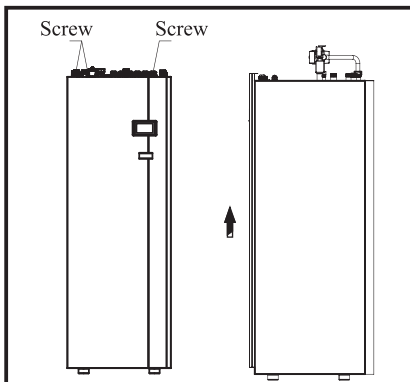

1. Unscrew the 3pcs screws on top of front panel.

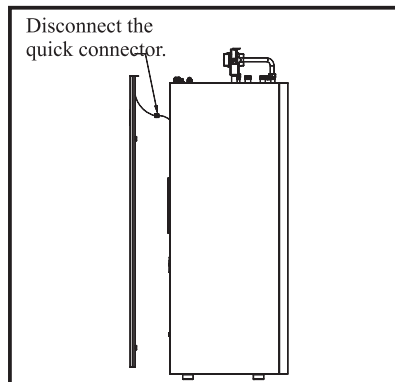

2. Hold the front panel up by 10~15mm, disconnect the quick connector from wired controller, and then take out the front panel.

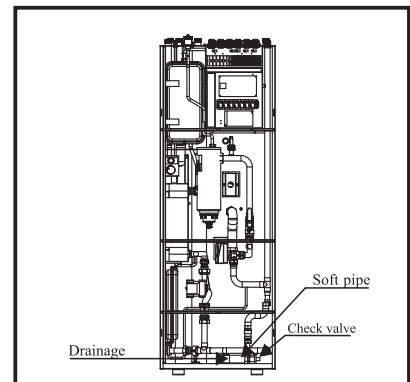

3. A soft pipe and ball valve have already been connected to the tank. please pull it out from the unit.



## 4. Installation Walkthrough

### 4.8. Installation of the kits in the accessories

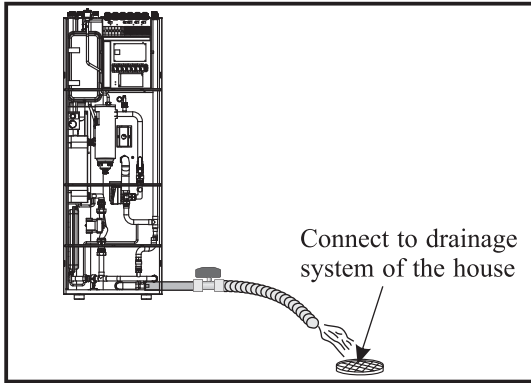

3. Drain the water to drainage system of the house, and open the ball valve to drain out all water inside the tank. Please extend the drainage pipe by connecting another water pipe, if the distance between the unit and drainage system is long.

#### 【Insulation】

All pipes running hot water should be well insulated. The insulation must be tied up tightly without gap (But please don't wrap up the check valve for future maintenance).



*Please ensure enough water pressure to deliver the water to the required height. If the water pressure is not enough, please add water pump to increase the pumping head.*

#### 【Four-way safety valve kit】

Four-way safety valve kit includes T/P valve, air purging valve and water pressure gauge. Please make sure it's in the accessories.

1. Take the four-way safety valve kit from accessories.
2. Apply sealant tape on threads of all the valves according to the industry standards.
3. Find the connector on the top of tank according to the label, and install the safety valve kit onto it.
4. Connect the drainage pipe to the T/P valve as shown in the picture.
5. After install the safety valve kit, please loose the small screw cap on the top of air purging valve in order to ensure the gas can be drained away.

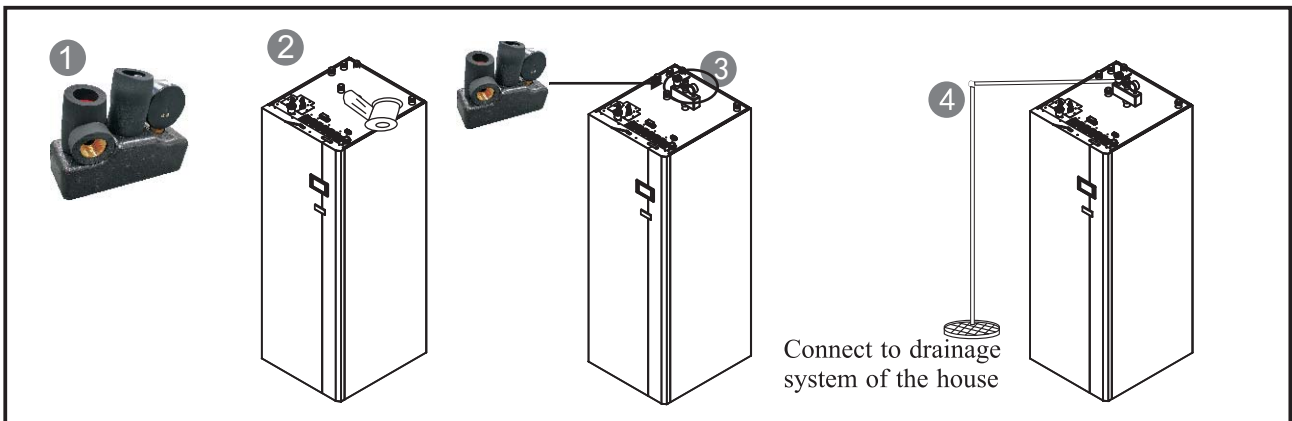

# 4. Installation Walkthrough

## 4.8. Installation of the kits in the accessories

### 【L type decorative panel in back side】

When the pipings are installed in back side of the unit, L type decorative panel can be installed as follows, in order to hide the pipings in backside and look better:

1. Take out 2pcs L type decorative panel in back side 1 and 1pcs L type decorative panel in back side 2.
2. Find 14 screws holes in the picture 2.
3. Fix 2pcs long panel on the right and left back side of the unit, by fasten the screws, and fix 1pcs short panel on the top back side of the unit. Please refer the picture 3 and 4.
4. It's done. Please refer the picture 5.

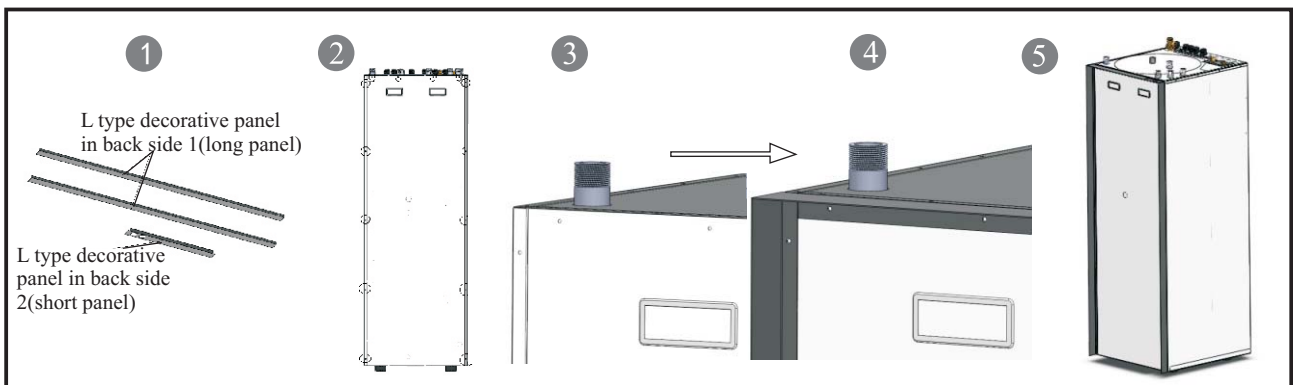

### 【Pipings for mixture valve】

It's used to connect the mixture valve with the unit.

1. Please find the pipings for mixture valve in the accessories. Please refer the picture 1.
2. Connect the pipings to two water inlets of mixture valve.
3. Install the pipings onto the high temperature hot water outlet and middle temperature hot water outlet. Please refer the picture 3 and 4.
4. It's done. Please refer the picture 5.

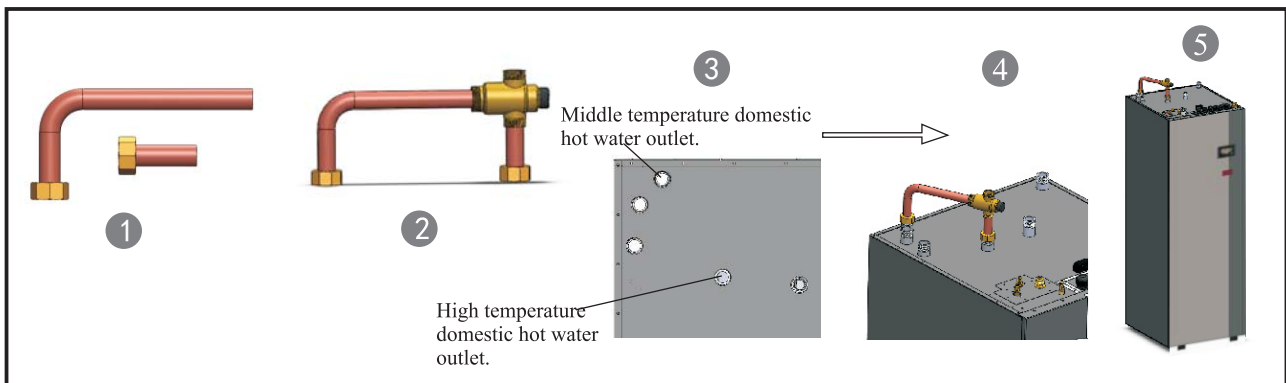

# 4. Installation Walkthrough

## 4.9. Wiring

For “NPT” Series

### 4.9.1. Explanation of Terminal Block 1

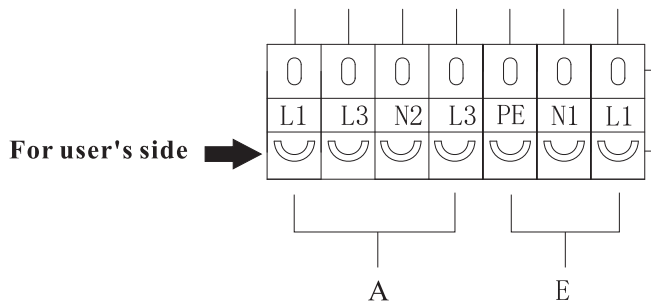

#### **A: Unit power supply**

This should be connected directly to the city power supply.

For all units, ensure that a cable of sufficient gauge is used. (found on nameplate)

#### **E: Outdoor unit power supply(for split units)**

If the outdoor unit draws power from the indoor unit, this terminal should be connected through cable between the appropriate ports (see Appendix for wiring diagrams).

#### **Outdoor E-Heater power supply(for monblock units)**

For supplying electricity to electric heater in outdoor unit, so in case the circuit breaker for outdoor unit power supply is cut, this heater can still have power preventing water from freezing up.

# 4. Installation Walkthrough

## 4.9. Wiring

For “NPT” Series

### 4.9.2. Explanation of Terminal Block 2

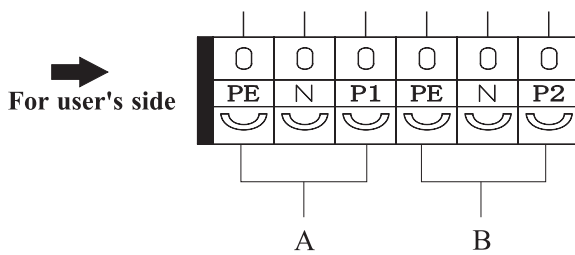

#### A, B: Water Pump

A-Pump 1: Pump for Heating & Cooling Circuit 1,  
B-Pump 2: Pump for Heating & Cooling Circuit 2,

If there is an external water pump in heating, cooling and hot water system, it can be connected to these ports, to be under the control of heat pump,

# 4. Installation Walkthrough

## 4.9. Wiring

For “NPT” Series

### 4.9.3. Explanation of Terminal Block 3

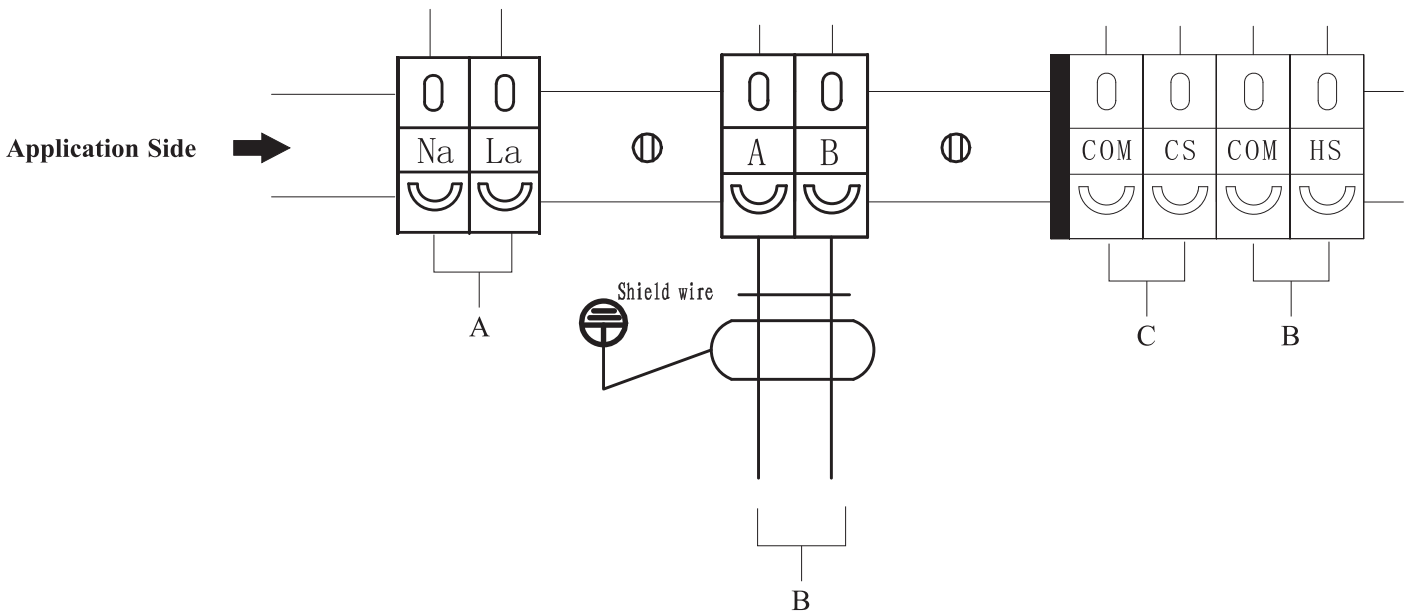

**A:** Signal output to Hot Water Tank Backup Heater (HWTBH), which will be used as backup heating source for DHW operation only.

**B:** Signal cable between indoor and outdoor unit.

#### **C, D: Cooling and Heating Mode Switchovers**

This unit is capable of switching between heating and cooling automatically, according to the ambient temperature, or external signal input. Please refer to the user’s manual for more detailed explanations on ambient temperature setting. For external signal input, the external signal should be connected to “Cool Mode Switch” for cooling operation, and “Heat Mode Switch” for heating operation.

# 4. Installation Walkthrough

## 4.9. Wiring

For “NPT” Series

### 【Important Notice】

**With 415V/50Hz/3Ph power supply (as default):**

Use wiring diagram A1. L1, L2 and L3 from terminal block T2 should be connected to terminal R, S and T of terminal block T1; N1, N2 and N3 from terminal block T2 should be connected to terminal N of terminal block T1. Power supply cable must be able to carry the maximum running current of the system (recommand to use power cable no smaller than 2.5mm<sup>2</sup>).

**With 230V/50Hz/1Ph power supply:**

Use wiring diagram A2. L1, L2 and L3 from terminal block T2 should be connected to terminal R of terminal block T1; N1, N2 and N3 from terminal block T2 should be connected to terminal N of terminal block T1. Power supply cable must be able to carry the maximum running current of the system (recommand to use power cable no smaller than 10mm<sup>2</sup>).

**With 230V/50Hz/3Ph power supply:**

Use wiring diagram A3. L1 and N1 from terminal block T2 should be connected to terminal R of terminal block T1; L2 and N2 from terminal block T2 should be connected to terminal S of terminal block T1; L3 and N3 from terminal block T2 should be connected to terminal T of terminal block T1; Power supply cable must be able to carry the maximum running current of the system (recommand to use power cable no smaller than 6mm<sup>2</sup>).

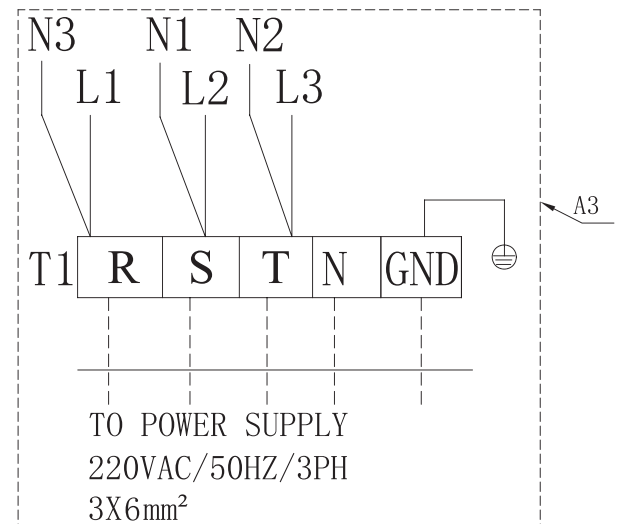
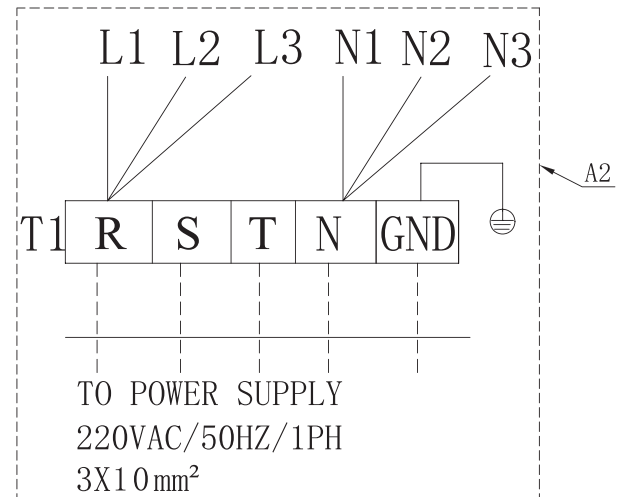
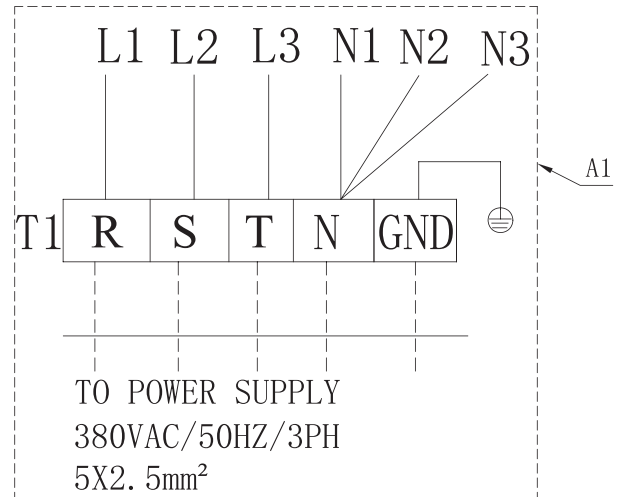

# 4. Installation Walkthrough

## 4.9. Wiring

### For “NPET” Series

Nordic Plus Enamelled Tank All-in-One Unit,6/9/11/13kW

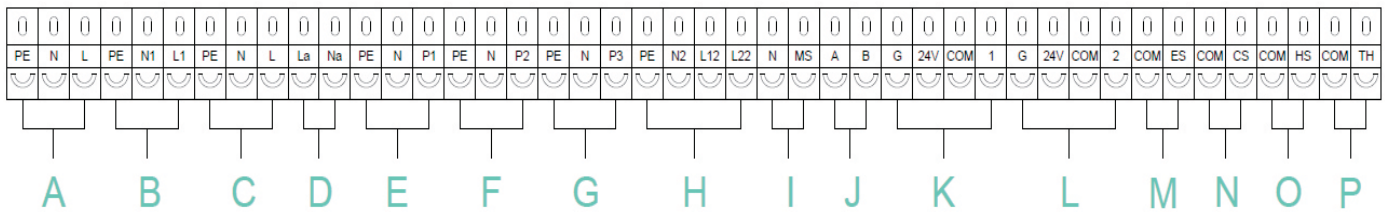

- A** HEAT PUMP POWER SUPPLY (FUSE-20 A 1PC)
- B** POWER SUPPLY ELECTRICAL HEATER FOR DHW TANK ( FUSE-1X10A P C)
- C** INDOOR TO OUTDOOR POWER CONNECTION (230V) - 3X2.5mm<sup>2</sup>
- D** CONSTANT 230V RESERVE - MAX. LOAD 100 W
- E** CIRCULATING PUMP - HEATING/COOLING CIRCUIT 1
- F** CIRCULATING PUMP - HEATING/COOLING CIRCUIT 2
- G** CIRCULATING PUMP FOR DHW (230V on P3 during DHW operation)
- H** INTERNAL ELECTRICAL HEATERS POWER SUPPLY (FUSE -2X16A P C)
- I** MODE SWITCHING SIGNAL
- J** INDOOR TO OUTDOOR COMMUNICATION  
*Cable included in the package - 3X0.75mm<sup>2</sup> Shielded*
- K** MIXING VALVE 1(24V DC Power supply,0-10 V DC Signal)
- L** MIXING VALVE 2(24V DC Power supply,0-10 V DC Signal)
- M** ELECTRICAL UTILITY LOCK (see page 64)
- N** EXTERNAL SWITCH INPUT FOR COOLING MODE (0/1)
- O** EXTERNAL SWITCH INPUT FOR HEATING MODE (0/1)
- P** EXTERNAL SWITCH INPUT FOR HIGH TEMPERATURE DEMAND (0/1)

## 4. Installation Walkthrough

### 4.9. Wiring

#### Power supply and electric connections

This unit has a maximum combined output (hot water and heating) of 16,5/18,5/20,5 kW (depending on model). To get maximum output, the unit needs a total of 11 kW power input. However, the unit's output and consumption can be adjusted in accordance to the available power input in the building, and type of backup heater you want to connect. The minimum input is 3 kW.

**Observe! If internal back up heaters are not connected, the heat pump must be connected to external automatic backup heating device for space heating and hot water.**

Before doing the electric installation you need to plan how much of the unit's total capacity you wish to use, and what kind of power supply that is available (230V or 400V, single phase or three phase). Below it is listed different power consumers built in the unit, and the power input and voltage needed to run them.

Power consumer	Power	Voltage	Circuit breaker	Explanation
Heat pump + hot water heater	3,5-4 kW	230V/1-ph	25A	Can be individually connected with 1-4 individual 230V/1-ph power supply
Backup heater 1	3,0 kW	230V/1-ph	16A	
Backup heater 2	3,0 kW	230V/1-ph	16A	
Heat pump + hot water heater + Backup Heater 1 + Backup heater 2	9,5-10 kW	400V/3-ph or 230V/3-ph	25A	Heating system connected to 400V/3-ph or 230V/3-ph power supply

**Note:** There has a "Emergency Switch" inside the unit. This switch should only be switched ON when compressor system is break down. When it is set to ON, it will activate the power connection to a 3kW heater, which shares the power supply of heat pump unit.



# 4. Installation Walkthrough

## 4.9. Wiring

### 4.9.4. Wiring Process Preliminary Precautions

- Please ensure that a suitable circuit breaker is used for the heat pump.
- The power supply to the heat pump unit must be grounded.
- Wiring should be done by a licensed professional, and comply with industry regulations.
- The unit should be completely powered off before any wiring is done.
- Cables should be properly fastened into place, to prevent loosening from occurring.
- No cable should be fastened to another.
- The power supply should be compliant to all standards located in the rating label.
- The power supply, necessary cables, and sockets should fully meet the input power requirements of the unit.

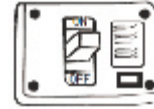

#### Installation sketch

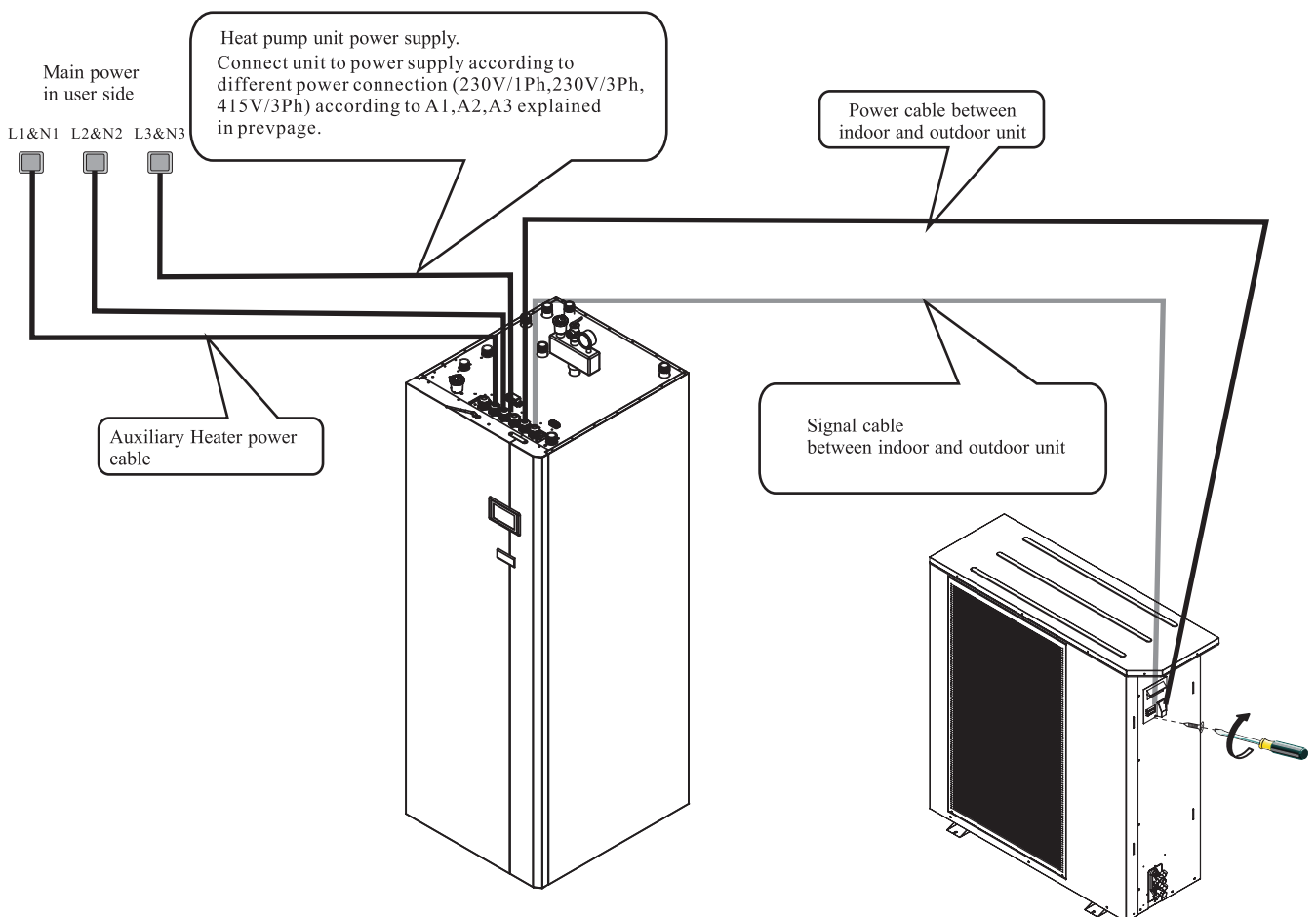

# 4. Installation Walkthrough

## 4.9. Wiring

### 4.9.5. Wiring Process

1) Open the indoor unit's front panel and remove the electrical box cover.

#### 【Connect of drainage pipe】

When the tank need to be drained, please do as per following instruction:

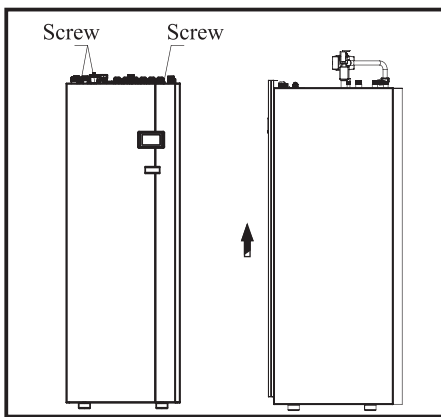

1. Unscrew the 3pcs screws on top of front panel.

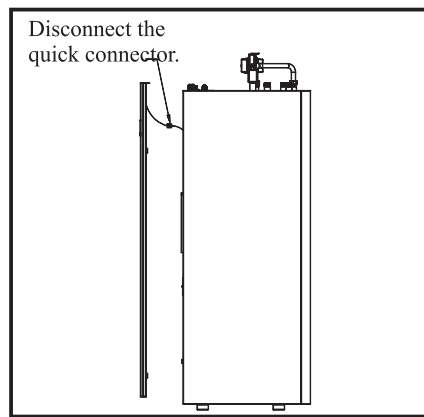

2. Hold the front panel up by 10~15mm, disconnect the quick connector from wired controller, and then take out the front panel.

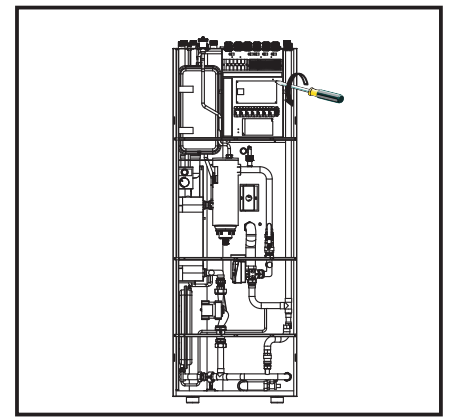

3. A soft pipe and ball valve have already been connected to the tank. please pull it out from the unit.

2) Acquire power cables of suitable length that is compliant to all local safety regulations.

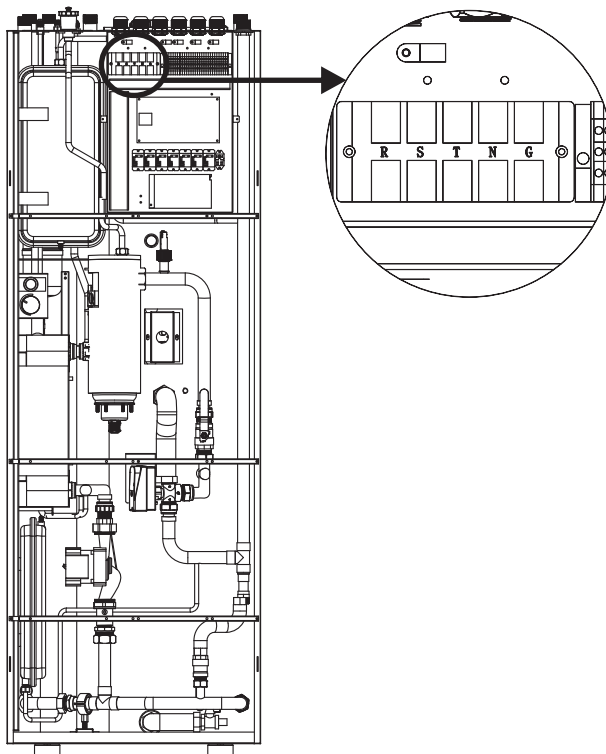

Connect power cables to the power supply terminal inside the unit.

## 4. Installation Walkthrough

### 4.9. Wiring

- 3) Connect the signal cable between the indoor and outdoor unit:  
Retrieve the signal cable from the accessories bag.

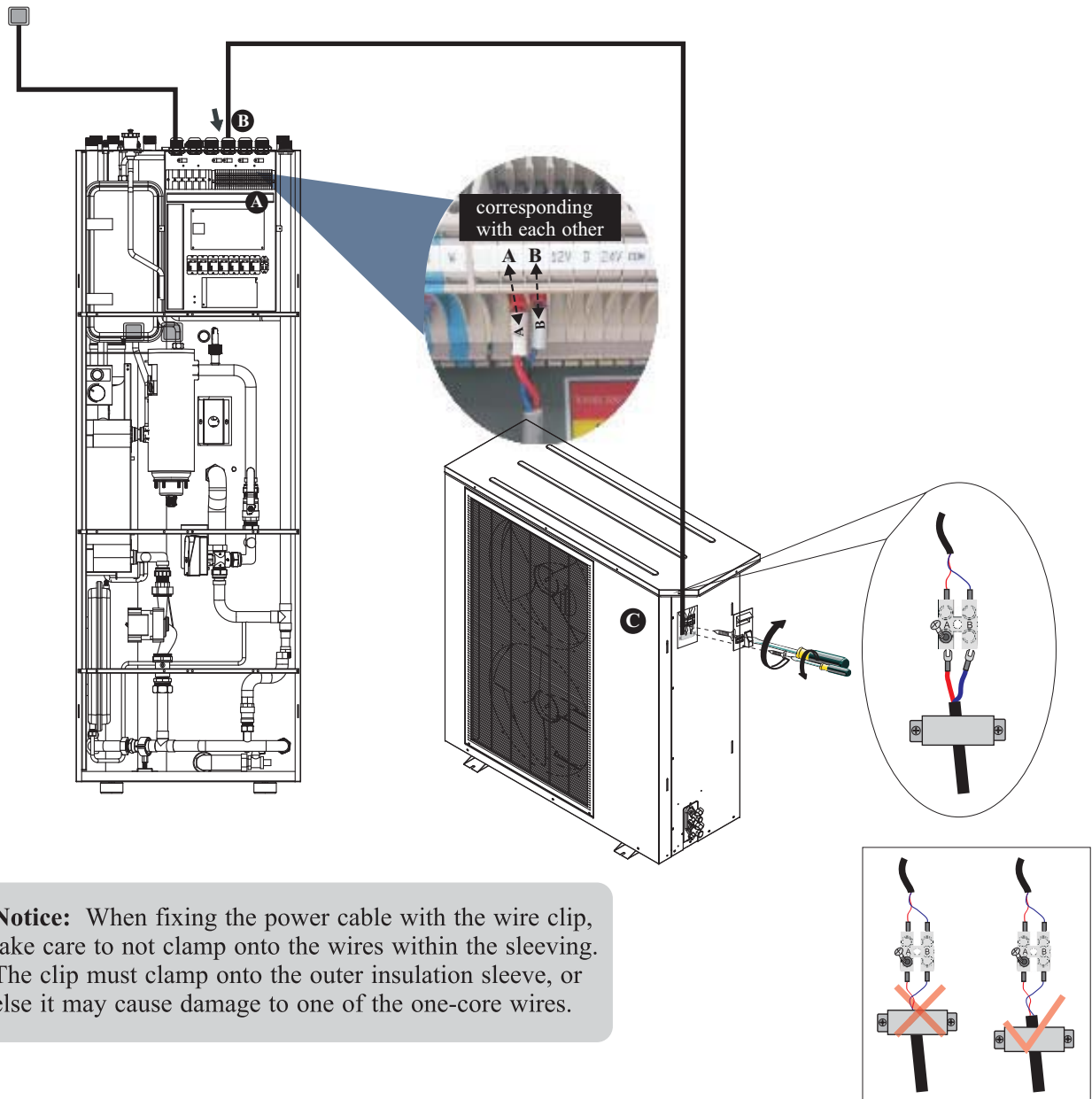

**Notice:** When fixing the power cable with the wire clip, take care to not clamp onto the wires within the sleeving. The clip must clamp onto the outer insulation sleeve, or else it may cause damage to one of the one-core wires.

- Insert one end of this cable through the cable gland on the top of the indoor unit, and connect it to A and B on the appropriate terminal block.
- Fasten the cable gland to ensure the cable won't get loosen.
- Connect the other end of the cable to the terminal block on the outdoor unit. A and B on the indoor unit should be connected with A, B, and G on the outdoor unit, otherwise communication failure error may occur.

For monoblock unit, connect sensor cables and flow switch cables between indoor and outdoor unit as per wiring diagram and marks on the cable.

# 4. Installation Walkthrough

## 4.9. Wiring

- 4) Connect the power cable between the indoor and outdoor unit (For split units) :  
Connect the power cable between the indoor and Outdoor Unit' s E-Heater(For monoblock units)  
Acquire a 3-core power cable of sufficient length that is compliant to all local safety regulations.

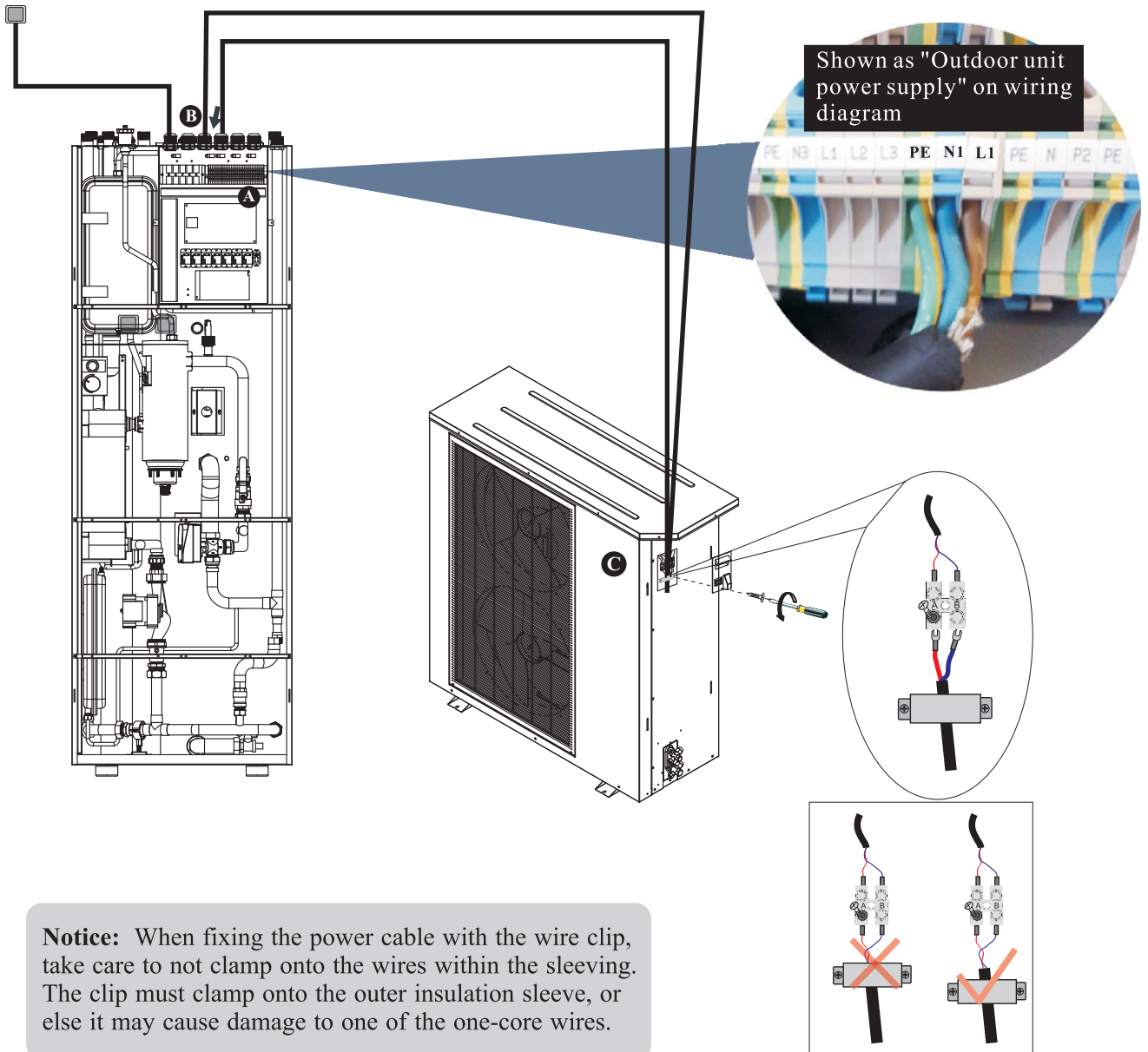

- A. Insert one end of this cable through the cable gland on the bottom of the indoor unit, and connect it to A and B on the appropriate terminal block.
- B. Fasten the cable gland to ensure the cable won't get loosen.
- C. Connect the other end of the cable to the terminal block on the outdoor unit. A and B on the indoor unit should be connected with A, B, and G on the outdoor unit, otherwise communication failure error may occur.

## 4. Installation Walkthrough

### 4.9. Wiring

- 6) Tc (cooling&heating water temperature sensor) and Tr (room temperature sensor) are pre-connected and put inside the indoor unit. Following below instructions if they need to be moved to another place.

- Retrieve all sensors and communication cables from the accessories bag.
- Connect all sensors to the communication cables, and insert the male end into the indoor unit through the cable glands.
- Connect them to the female quick connectors inside the indoor units.
- Place all sensors in the correct positions.
- After everything is connected, fasten the cable glands to prevent cables from loosening.

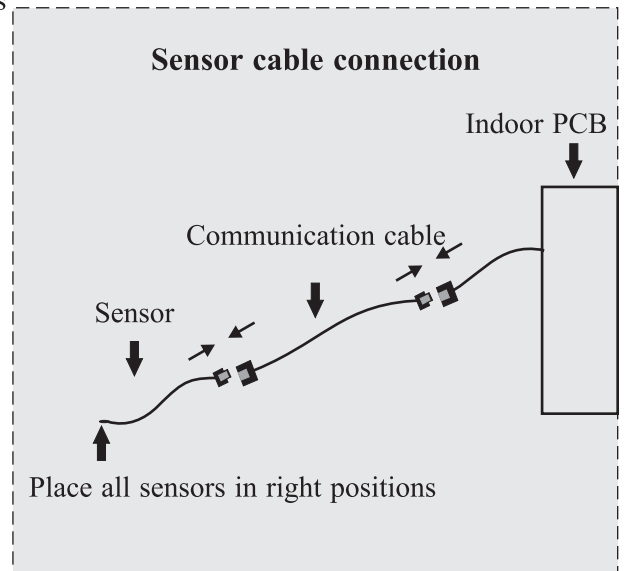

- 7) Re-install the electrical box cover, as well as the small handle on the back of the outdoor unit, and close the the indoor unit door.

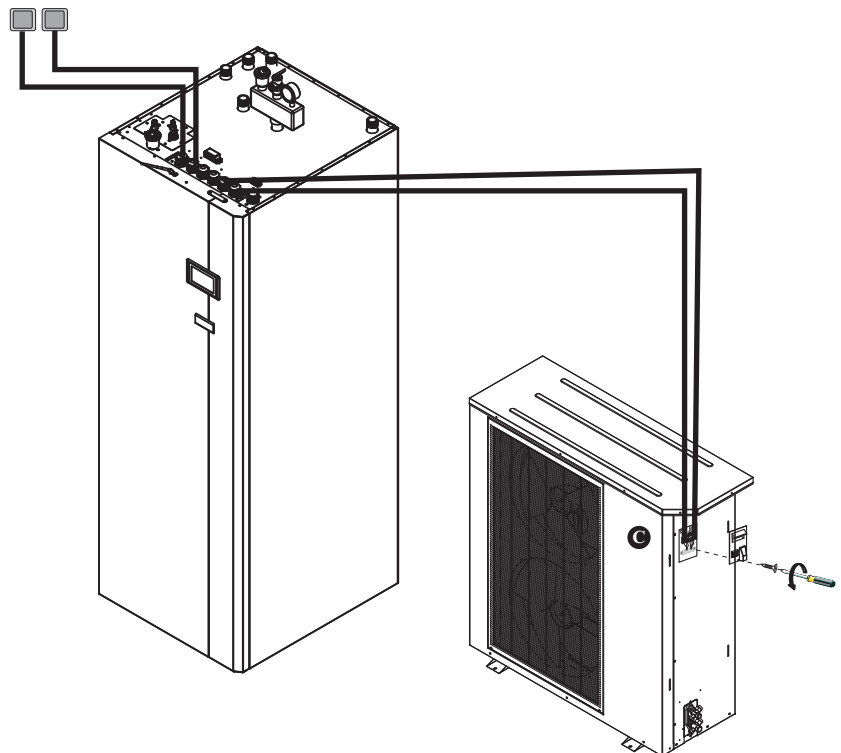

The wiring process is then complete.

## 4. Installation Walkthrough

---

### 4.10. Attention

---



- A. The user mustn't change the structure or wiring inside the unit.
- B. The service and maintenance should be performed by qualified and well-trained technician. When the unit fails to run, please cut off power supply immediately.
- C. The smart control system can automatically analyze various protection problems during daily use, and display the failure code on the controller. The unit may recover by itself. Under normal operation, the pipings inside the unit don't need any maintenance.
- D. Under normal running, the user only needs to clean the surface of the outdoor heat exchanger per month or quarter of a year.
- E. If the unit runs in a dirty or oily environment, please clean the outdoor heat exchanger and heat exchanger by professionals, using specified detergent, to ensure the performance and efficiency of the unit.
- F. Please pay attention to the ambient environment, to check if the unit is installed firmly, or if the air inlet and outlet of the outdoor unit is blocked or not.
- G. Unless the water pump is damaged, no service or maintenance should be taken to the water system inside the unit. It's recommended to clean water filter regularly or change it when it's very dirty or blocked.

## 4. Installation Walkthrough

### 4.11. Electric heating

This unit has included two electric heaters inside. Two electric heaters are used to keep the water temperature when heat pump capacity is not enough or heat pump fail to work, as well as heat the water up more rapidly when water temperature is low.

#### 【500W electric heater】

1. 500W electric heater only can be controlled by digital thermostat.
2. Power supply is 230V/50Hz/1Ph, and temperature setting range is 30~75°C.
3. This heater is mainly used to get high temperature sanitary hot water or get hot water faster.
4. If heat pump fails to work, this heater can still work.

Operation knob for 500W heater is on front panel, for easy access. Please refers to following picture.

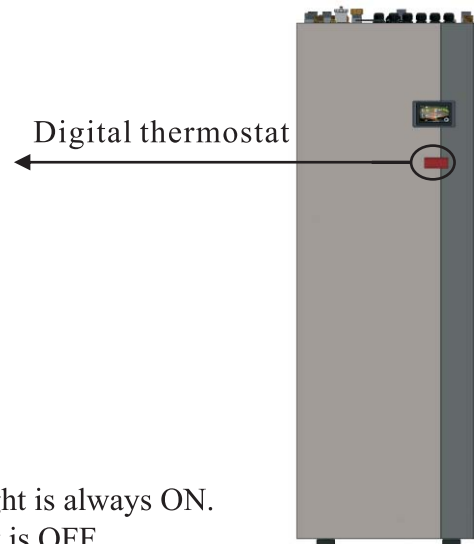
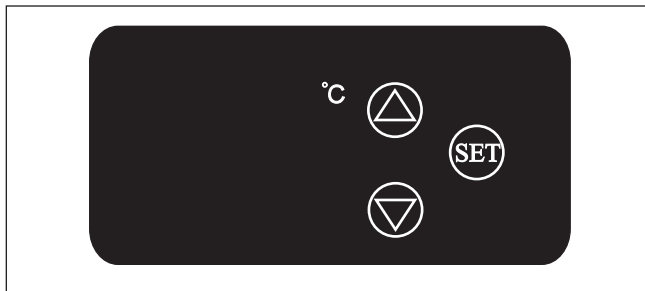

#### 【Digital thermostat】

Power supply: 110~240V.

Indicator light OUT

When the electric heater is turned on, the indicator light is always ON.

When the electric heater is turn off, the indicator light is OFF.

Temperature setting: Press SET, the set temperature flickers, press ▲ or ▼ to increase or decrease the set temperature. The controller will save the setting.

Press SET again to exit and show the actual water tempeture in the display. If SET is not pressed, the controller will also exit the setting after 3 seconds and show the actual water temperature in the display.

Control logic

When the thermostat is powered on, the display shows the actual water temperature. When the actual water tempeture is lower than (the set tempeture-3°C), the electric heater is turned on.

When the actual water temperature equals or higher than the set temperature, the electric heater stops.

Failure code

When the actual temperature which sensor detects is higher than 120 °C or the sensor for thermostat is short circuit, the display shows the failure code HH, and the electric heater stops.

When the actual temperature which sensor detects is lower than -45 °C or the sensor for thermostat is open circuit, the display shows the failure code LL, and the electric heater stops.

## 4. Installation Walkthrough

### 4.11. Electric heating

Notice:

1. Please connect the cables according the wiring diagram.
2. The sensor cable can't be packed with power cable or communication cable, please connect them separately, in order to avoid interference.
3. Sensor can't be dip into the hot water for a long time.
4. The thermostat initilize the setting the first second after power on, so don't touch the button in the first second.
5. When the thermostat start to work, please remove the film on the display.

When heat pump capacity is not enough, or heat pump meets a failure, indoor PCB will turn ON the internal heater automatically.

However, if the indoor PCB itself is broken, one can obey the following instructions to turn ON the heater manually:

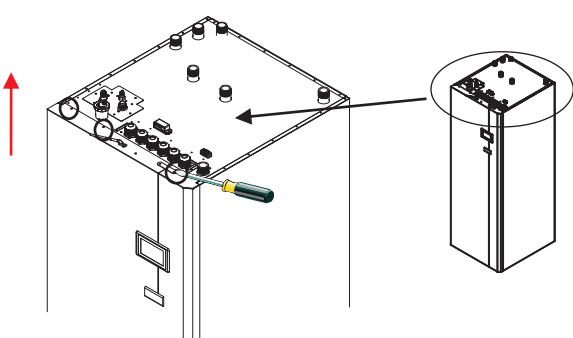
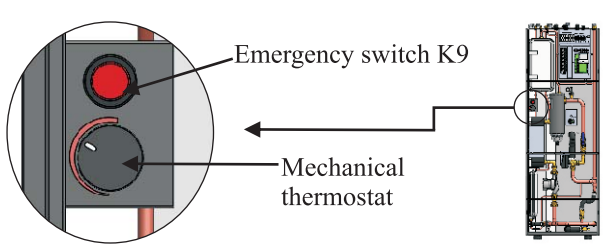
<p>1</p> 	<p>2</p> 
<p>Unscrew three screws on top, and lift the front panel up by around 20mm, then remove the front panel.</p>	<p>Switch ON the switch K9 inside the unit, as shown in below picture.</p>



# 4. Installation Walkthrough

## 4.11. Electric heating

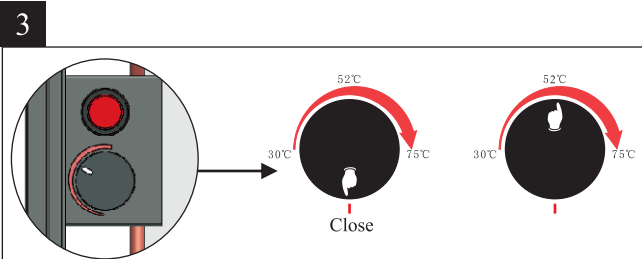

Set the needed water temperature by turning the knob of the mechanical thermostat, so to control the water temperature.

Note:  
The control temperature range for the mechanical thermostat is 30~75 °C .If the knob of mechanical thermostat is set between 30 and 75 °C , the mechanical thermostat is ON.  
If the knob of machnical thermostat is set below 30 °C , the mechanical thermostat is OFF.

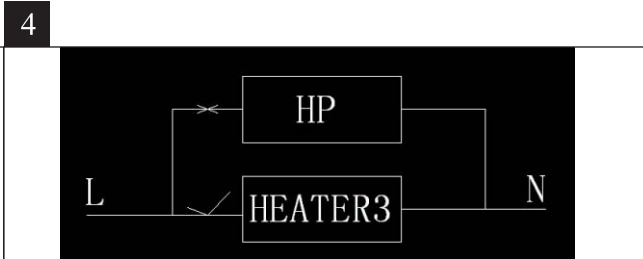

After the emergency switch is set to ON, heat pump power supply will be switched to the last 3kW. If the water temperature is lower than what is set via the thermostat, all 3 sets of 3kW heater will be started at the same time, so to have balanced 3 phase 9kW electric heater as the heating source.  
Please use this "emergency switch" when heat pump breaks down, and set it back to "OFF" once the heat pump unit is OK.

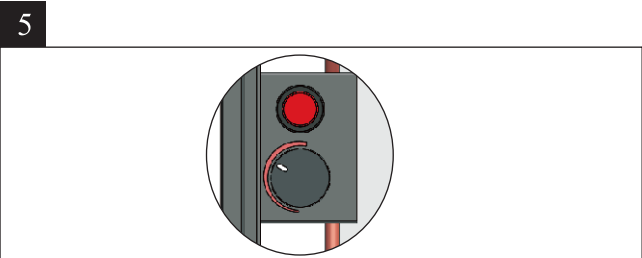

Note:  
After problem solved, please don't forget to turn the switch K9 to OFF position, otherwise electric heater will keeps on working if actual water temperature is lower than the set value of the mechanical thermostat.

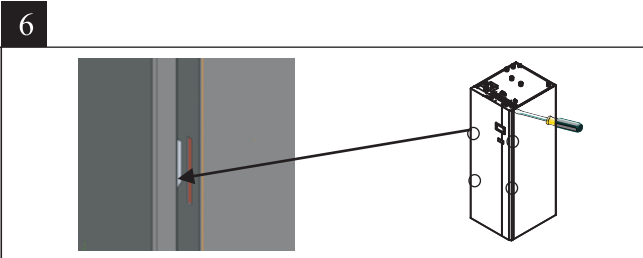

Please insert the hooks of the front panel to the holes as shown in the picture, then fix the front panel by fasten three screws on top.

## 4. Installation Walkthrough

---

### 4.12. Test run

---



After installation finished, please fulfill the water system with water and purge out air in the system before start-up.

#### 4.12.1. Before start-up

The list of verifications below must be performed before the unit starts up, to ensure best possible conditions for smooth long-term operation. The list is not exhaustive, and should only be used on a minimum reference basis:

- 1) Make sure the fans are rotating freely.
- 2) Confirm correct flow directions in water piping.
- 3) Verify all system piping matches installation instructions.
- 4) Check the voltage of the unit power supply and make certain it complies to authorized limitations.
- 5) The unit must be properly grounded.
- 6) Check for the presence of any damaged devices
- 7) Check all electrical connections and ensure they are secure.
- 8) Make sure there are no leaks in the piping and the space is well-ventilated.

Fix any problems above if they occur. If everything above is satisfied, the unit can start up.

#### 4.12.2. Starting Up

When the installation of the unit is completed, all water system pipes are confirmed to be well-connected, air purging is done, there are no leakages or other problems, the unit can be powered on.

Turn on the unit by pressing the on/off button on the operation panel. Listen carefully for any abnormal noise or vibrations, and ensure the display of the wired controller is normal.

After the unit has been on for 10 minutes and no abnormalities have occurred, the start-up process is complete. For problems and troubleshooting, please refer to the Service and Maintenance manual.

*Final note: It is suggested to not run "heating" or "hot water" mode during ambient temperatures above 32°C , otherwise the unit may easily enter protection mode.*

# Appendix A: Wiring

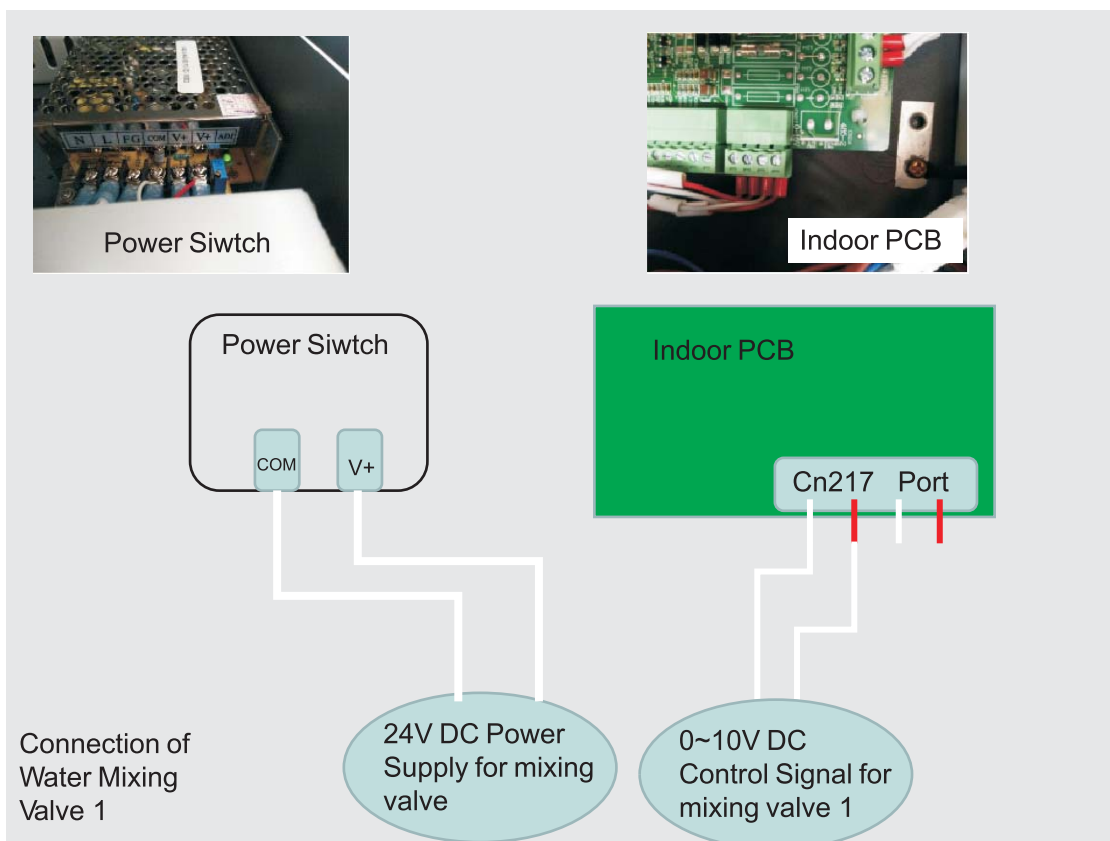
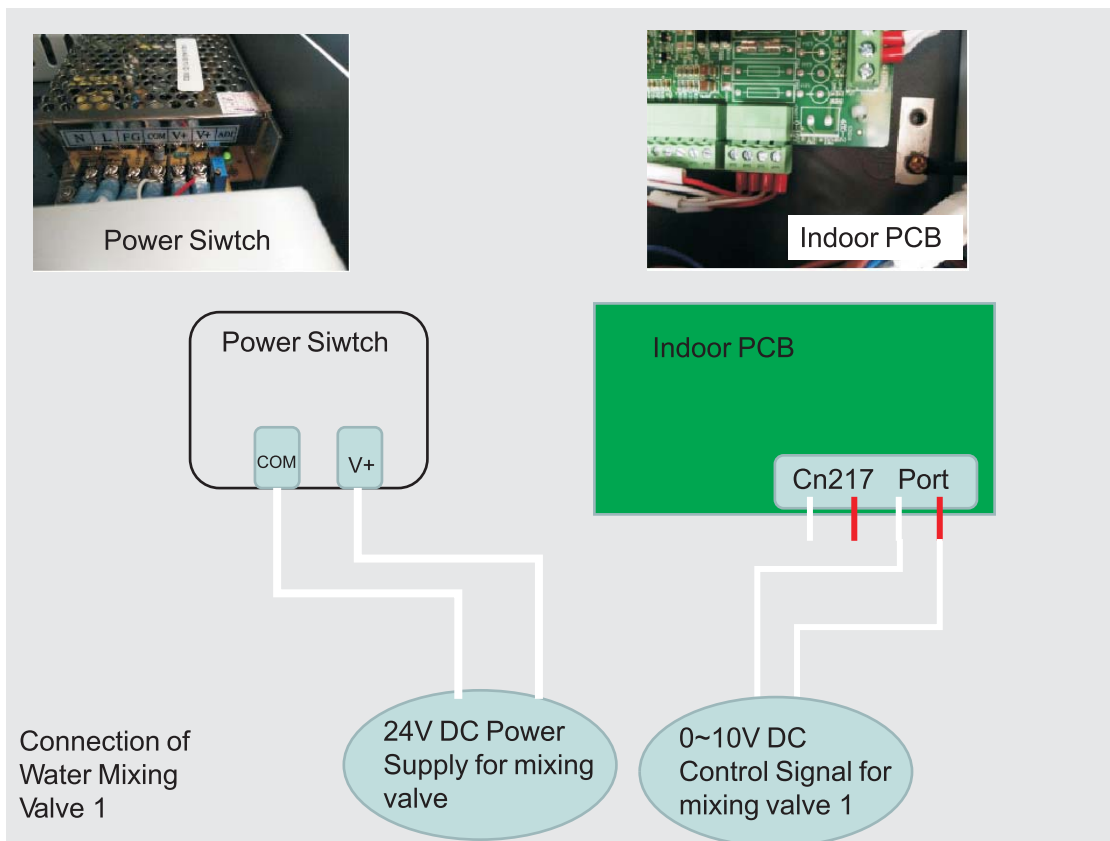

# Appendix A: Wiring

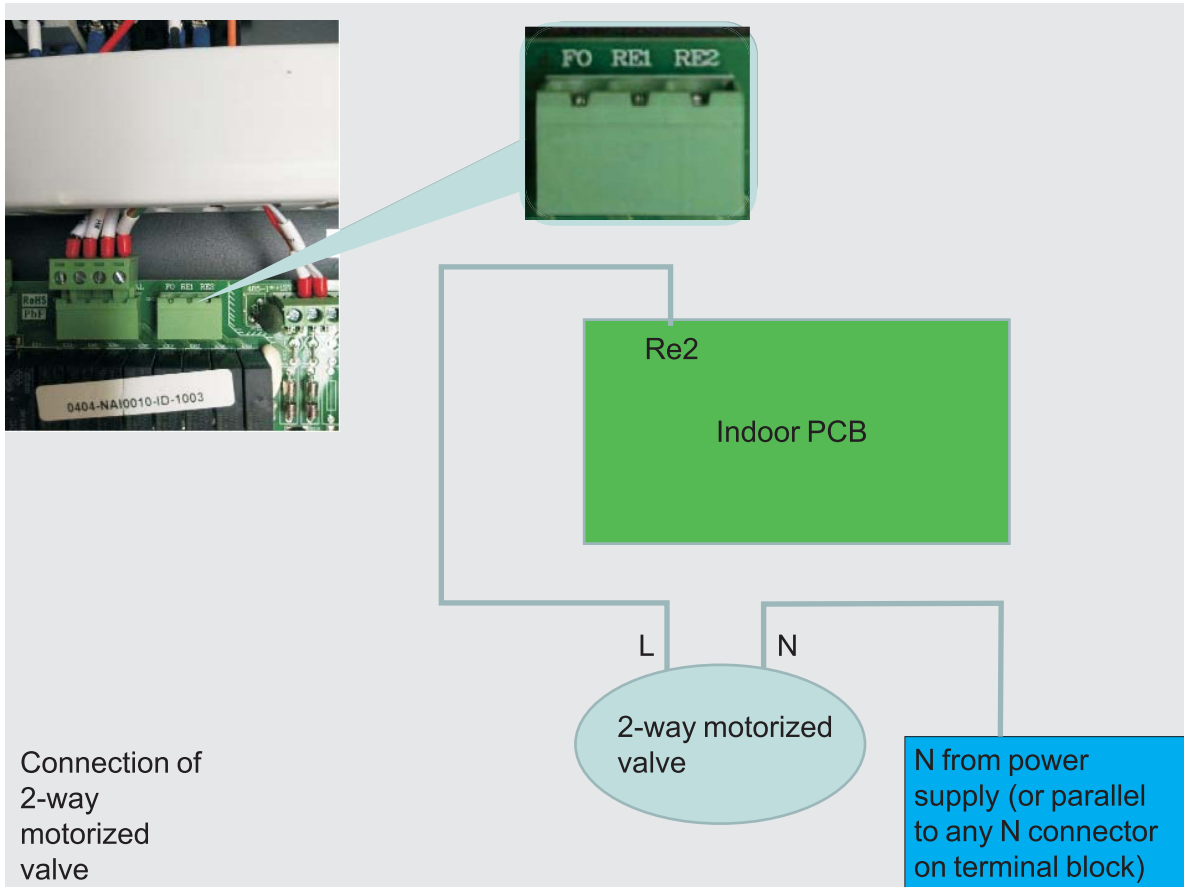

# Appendix B: Wiring

Indoor — NPT6/9/11/13-V7-S

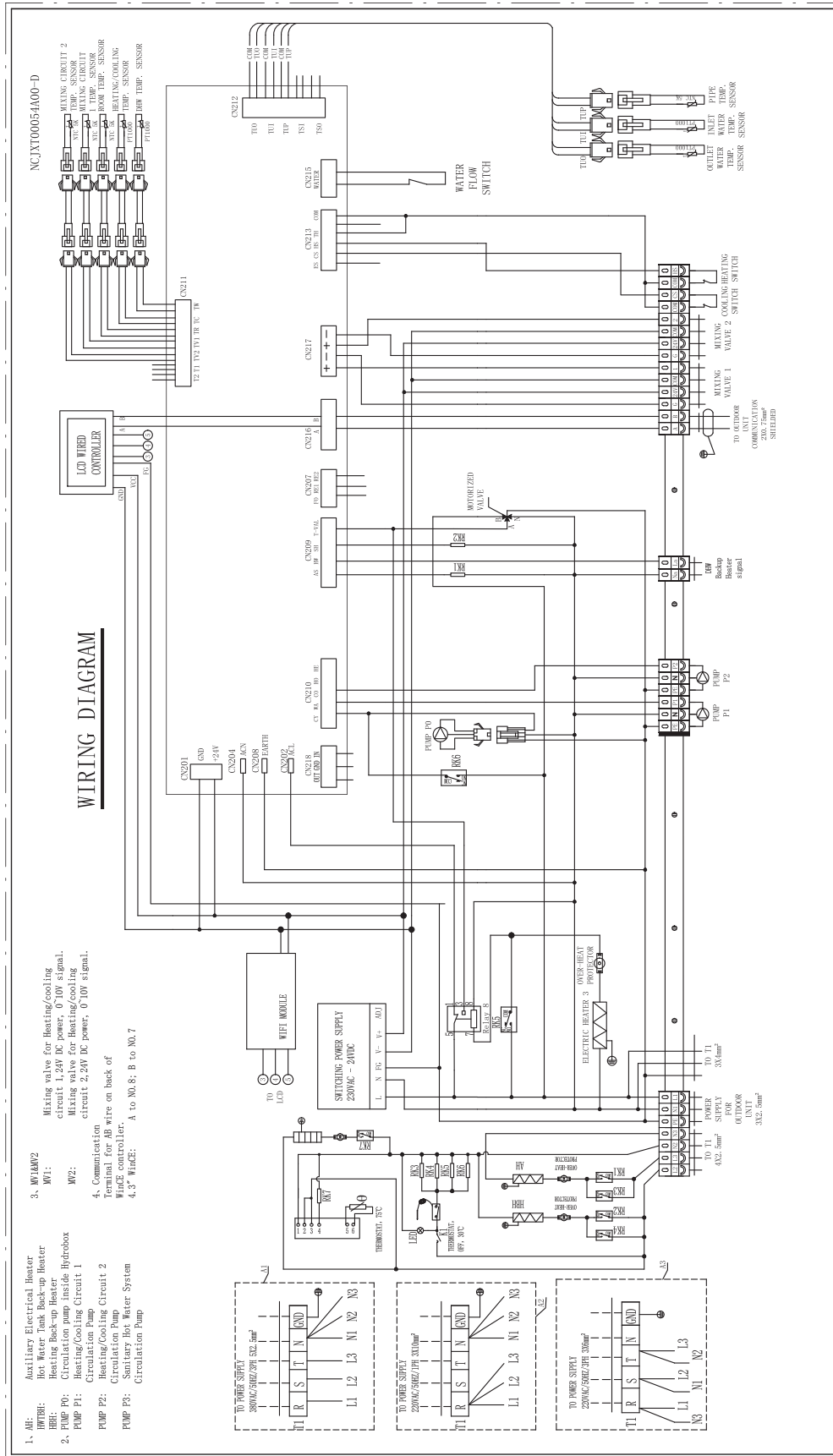

## TAKE CARE!

The specifications are subject to change without prior notice.

For actual specifications of the unit, please refer to the specification stickers on the unit.

# Appendix B: Wiring

## Indoor — NPET6-V7-S

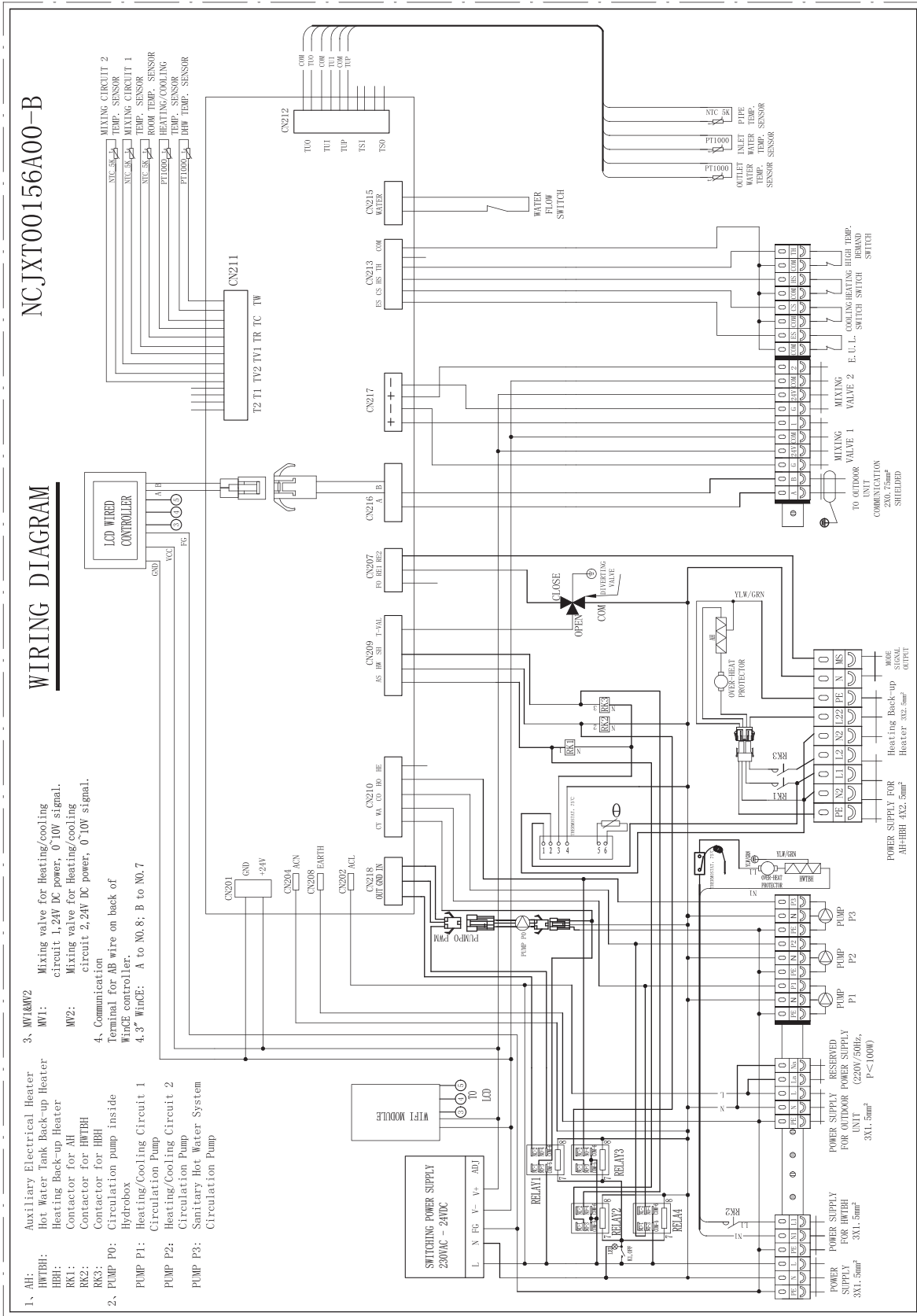

### TAKE CARE!

The specifications are subject to change without prior notice.  
For actual specifications of the unit, please refer to the specification stickers on the unit.

# Appendix B: Wiring

Indoor — NPET9/11/13-V7-S

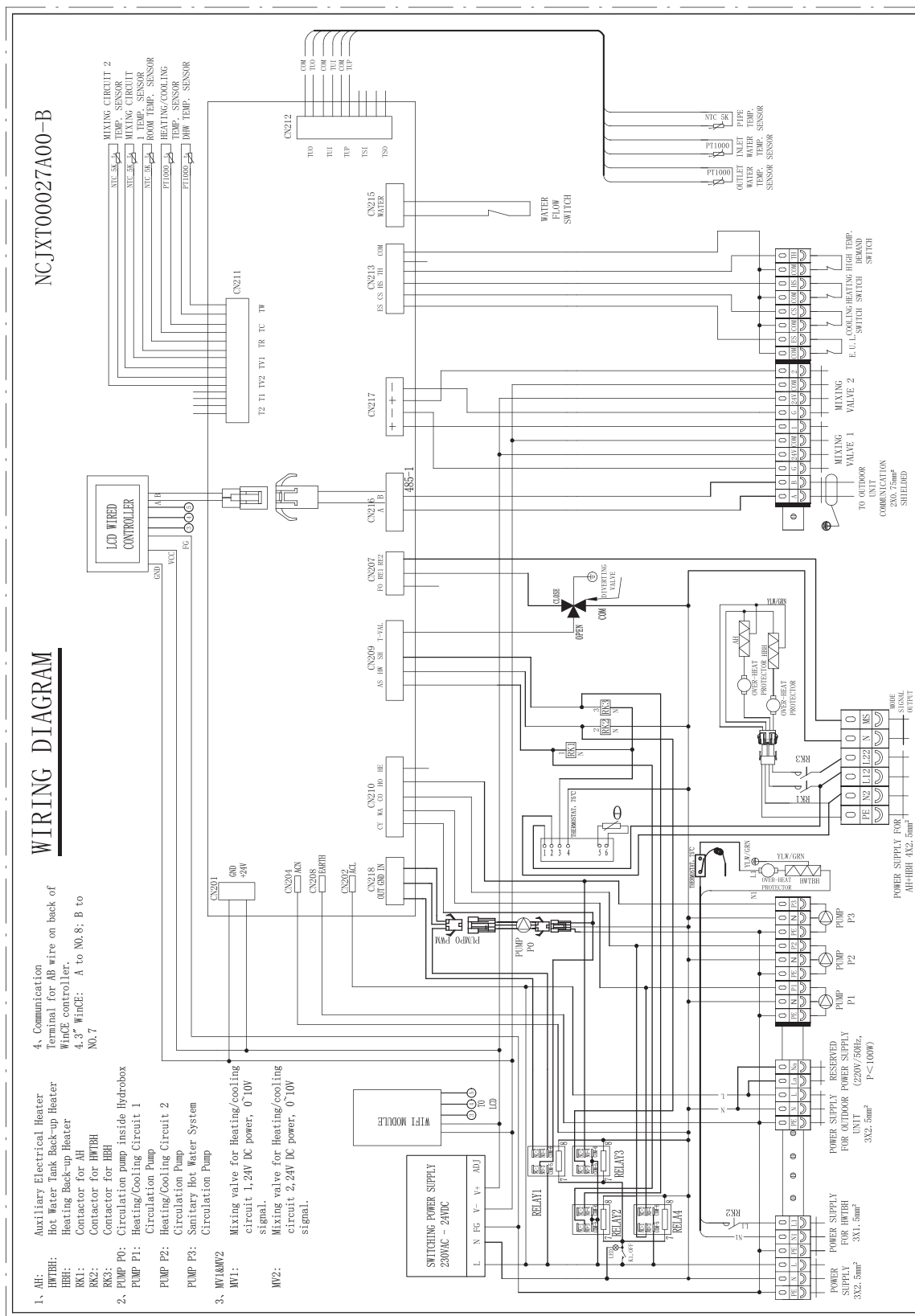

# Appendix B: Wiring

## Outdoor — NP6/9/11/13-V7-S

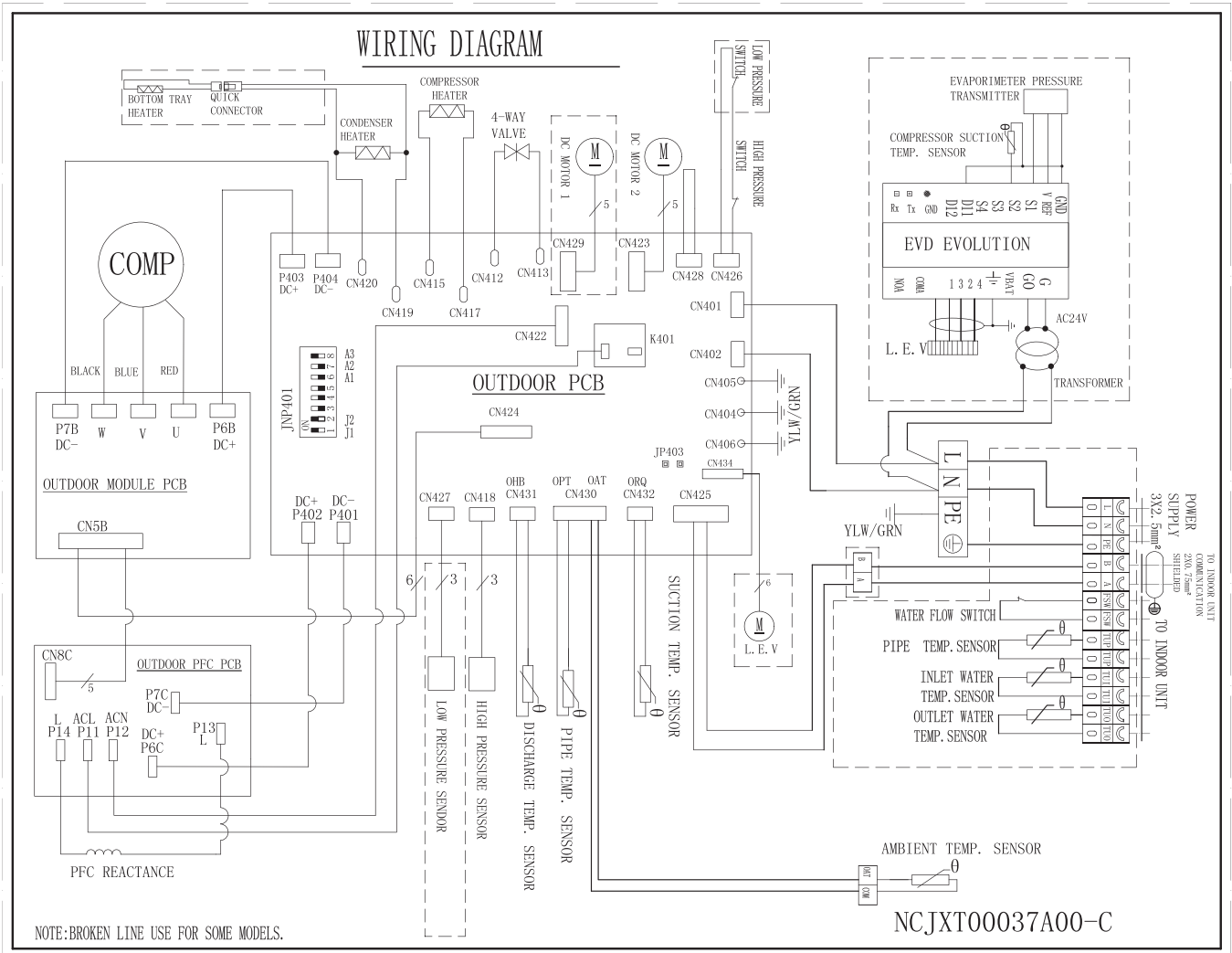

### TAKE CARE!

The specifications are subject to change without prior notice.

For actual specifications of the unit, please refer to the specification stickers on the unit.







ES Heat Pumps AB, 44138 Alingsås, Sweden  
info@energysave.se  
www.energysave.se

Thank you for purchase of our quality product.  
Please read this manual thoroughly before use , and  
follow the instructions carefully in operating the unit  
in order to prevent damages to either the device or persons.

Product specifications are subject to change with improvements ,  
without prior notice. Please refer to the specification sticker on  
the unit for the most recent specifications.

Please refer to the contact information  
below for technical support and enquiries:

**E-mail:**

**Telephone:**